



CONNECT AND PROTECT

Ready-to-Use Power Conductor: IBS & IBSB Advanced

Technical Guide

nvent

ERIFLEX

In accordance with its policy of continuous improvement, the Company reserves the right to change specifications and designs without notice. All illustrations, descriptions, dimensions and weights in this catalogue are for guidance and cannot be held binding on the Company.

Table of Content

IBS & IBSB Advanced Definition.....	4
IBS & IBSB Advanced Benefits.....	5
IBS & IBSB Advanced Applications	7
Technical Specifications.....	8
Dimensions and Packing unit.....	9
IBS & IBSB Advanced Selection	10
IBS & IBSB Advanced Current/Ampacities	11
IBS & IBSB Advanced Cable Cross Section Comparison	11
Skin Effect on Alternative	12
Skin Effect and Frequency	13
Power Dissipation	14
Short-Circuit.....	15
nVent ERIFLEX IBS & IBSB Advanced UL & CSA Certification.....	16
Flexibility and Bending Radius Comparison with Cable.....	17
Class II Insulation.....	18
Altitude Effect	20
Low Smoke (LS).....	20
Halogen-Free (HF)	21
Flame Retardant (FR).....	21
EN 45545-2 Fire Testing to Railway Components.....	22
Certifications for Marine & Offshore.....	23
Integral/Solid Palm Technology.....	24
Integral/Solid Palm Tensile Strength	25
Integral/Solid Palm Tinned Connection	26
Installation Time and Cost Saving Comparison with Cable & Lug.....	27
How to Achieve a Good Electrical Connection	28
nVent ERIFLEX IBS & IBSB Advanced Connection on MCCB.....	30
nVent ERIFLEX IBS & IBSB Advanced Connection on Power blocks.....	32
Fixing and Securing nVent ERIFLEX IBS & IBSB Advanced	34
Product Marking/Identification.....	39
Product Modification.....	40
nVent ERIFLEX IBS & IBSB Advanced Custom Solutions (Made to Order).....	43
Dedicated nVent ERIFLEX Software Available.....	43
Applications Pictures.....	44
Other nVent ERIFLEX Literature.....	48
Contact Us!.....	48

IBS & IBSB Advanced Definition

IBS & IBSB Advanced, Halogen-free
– Low smoke – Flame retardant
Insulated Braided Conductor for
Circuit Breakers

IBS & IBSB Advanced is the ideal ready-to-install flexible wire replacement solution specifically designed for connections to all molded case circuit breakers, including the most compact breakers on the market. IBS & IBSB Advanced connects to the front access terminals of the breakers without any additional accessories, such as angular connectors, spreaders, ring terminal connectors or extenders.

- **IBS & IBSB Advanced** is available in cross sections of 25 to 240 mm² (49.34 to 273.65 kcmil), lengths from 230 to 1,030 mm (9.06" to 40.55"), and 80 to 700 A tinned copper palm.

Manufactured in an ISO 9001 certified automated facility, IBS & IBSB Advanced is formed by weaving high-quality electrolytic copper wire to form a durable low voltage connector with maximum flexibility, allowing for more compact power connections to circuit breakers. IBS & IBSB Advanced allows users to reduce the total

size and weight of the installation, improving both design flexibility and assembly aesthetics.

The unique manufacturing process of integral pre-punched solid palms makes IBS & IBSB Advanced ready to connect out of the box. There are no lugs to purchase or install, making connections simpler, faster and also eliminates faulty connections due to vibration or fatigue.

IBS & IBSB Advanced is compatible with all major brand molded case circuit breakers.

The Advanced Technology

insulation is a high-resistance low smoke, halogen-free and flame retardant Thermoplastic (LSHFFR), with a 115°C maximum working temperature rating.

- IBS & IBSB Advanced does not generate corrosive gases and produces a relatively **low smoke** opacity in case of fire, in accordance with IEC 61034-2 and UL 2885. The low smoke characteristic improves visibility conditions to easily locate the emergency exit and also allows rescue workers to better assess an emergency situation. IBS & IBSB Advanced means enhanced safety

for individuals, less damage for your electrical equipment and less environmental impact.

- The **halogen-free** feature enables a reduction in the quantity of toxic smoke. IBS & IBSB Advanced does not contain any halogens, according to IEC 60754-1 and UL 2885, minimizing toxicity and making it the ideal product for use in enclosed spaces such as data centers, rail and places where people are present such as hospitals and schools. These also facilitate the use of IBS & IBSB Advanced in specific applications such as submarines, switchboards and other enclosed environments that require a low emissions solution.
- In addition to the above features, IBS & IBSB Advanced is compliant with the UL 94-V0 testing standard and Glow wire test 960°C. The **flame retardant** portion of the test illustrates the self-extinguish feature. This feature is also shown by the Limiting Oxygen Index (LOI) > 30%. In case of a fire, IBS & IBSB Advanced generates a limited quantity of smoke that is less damaging to your electrical equipment.



IBS & IBSB Advanced Benefits



Space and Weight Savings

- IBS & IBSB Advanced require less wire bending space than cable due to its high flexibility.
- With greater ampacities, a single piece of IBS & IBSB Advanced can replace multiple runs of cable.
- Protective sleeve and flexibility allows IBS & IBSB Advanced to be mounted in tight areas where rigid busbar or rigid cables cannot.
- No clearance distance needed around IBS & IBSB Advanced vs other phases or metallic parts due to Class II insulation characteristics.
- Integral solid palm without lugs or terminals reduces material and assembly weight.

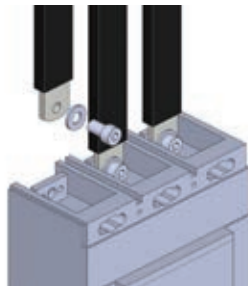
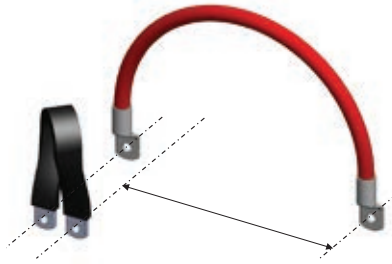

Operating Advantage

- IBS & IBSB Advanced are connectable on front access connections of the main molded case circuit breakers.
- Ring terminals or lugs are no longer needed as IBS & IBSB Advanced is already punched. No additional crimping operation is needed.
- Higher working temperature than cables allows users to address the potential hot connecting point from the electrical devices.

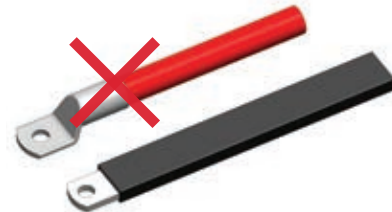

Time Saving

- IBS & IBSB Advanced is a ready-to-use conductor. No need for lugs or tools to fabricate the conductor. This reduces installation time and cost.
- Easier to bend and shape than large cables, making installation quicker.



Aesthetic Advantage

- Increases design flexibility.
- Neatly organizes hard-to-make connections.



Reliability & Safety Advantage

- IBS & IBSB Advanced is directly connected thus eliminating the cable lug connection and other source of heating point.
- Tinned protected palm for better corrosion resistance.
- Excellent resistance to vibration.
- No crimping.
- Less human error.
- Insulation sleeve manufactured from high-resistance low smoke, halogen-free and flame retardant Thermoplastic (LSHFFR), with 115°C high temperature.

IBS & IBSB Advanced Benefits



Worldwide certifications, applications and product availability

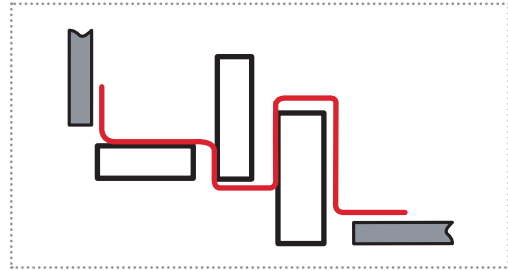

Easy connection for specific applications

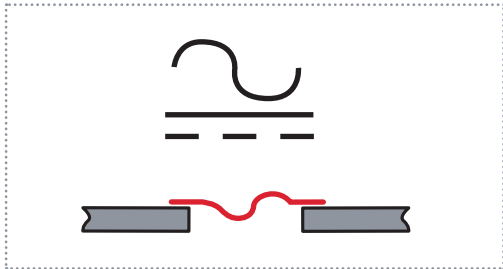

Connections for alternating current or direct current application

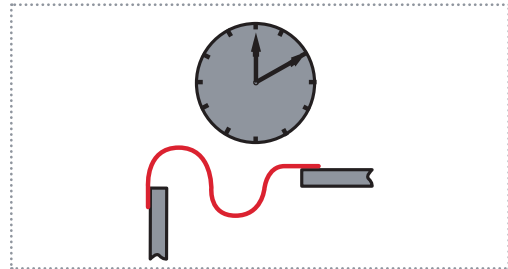

Reduces assembly time and maintenance connection

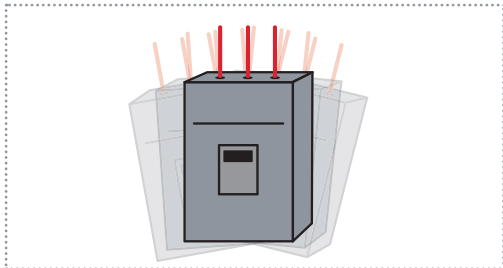

Reliable protection against vibrations in power connections

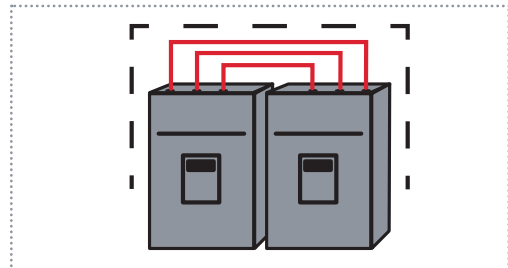

Short and compact connection between electrical components for volume reduction

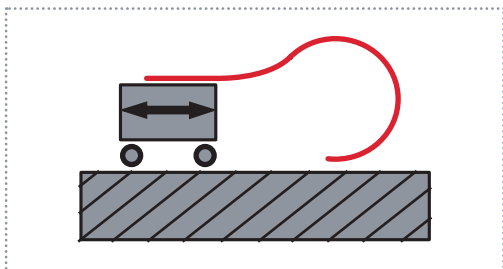

Flexible connection between fixed and moving parts

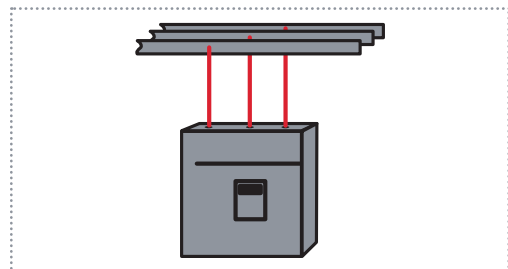





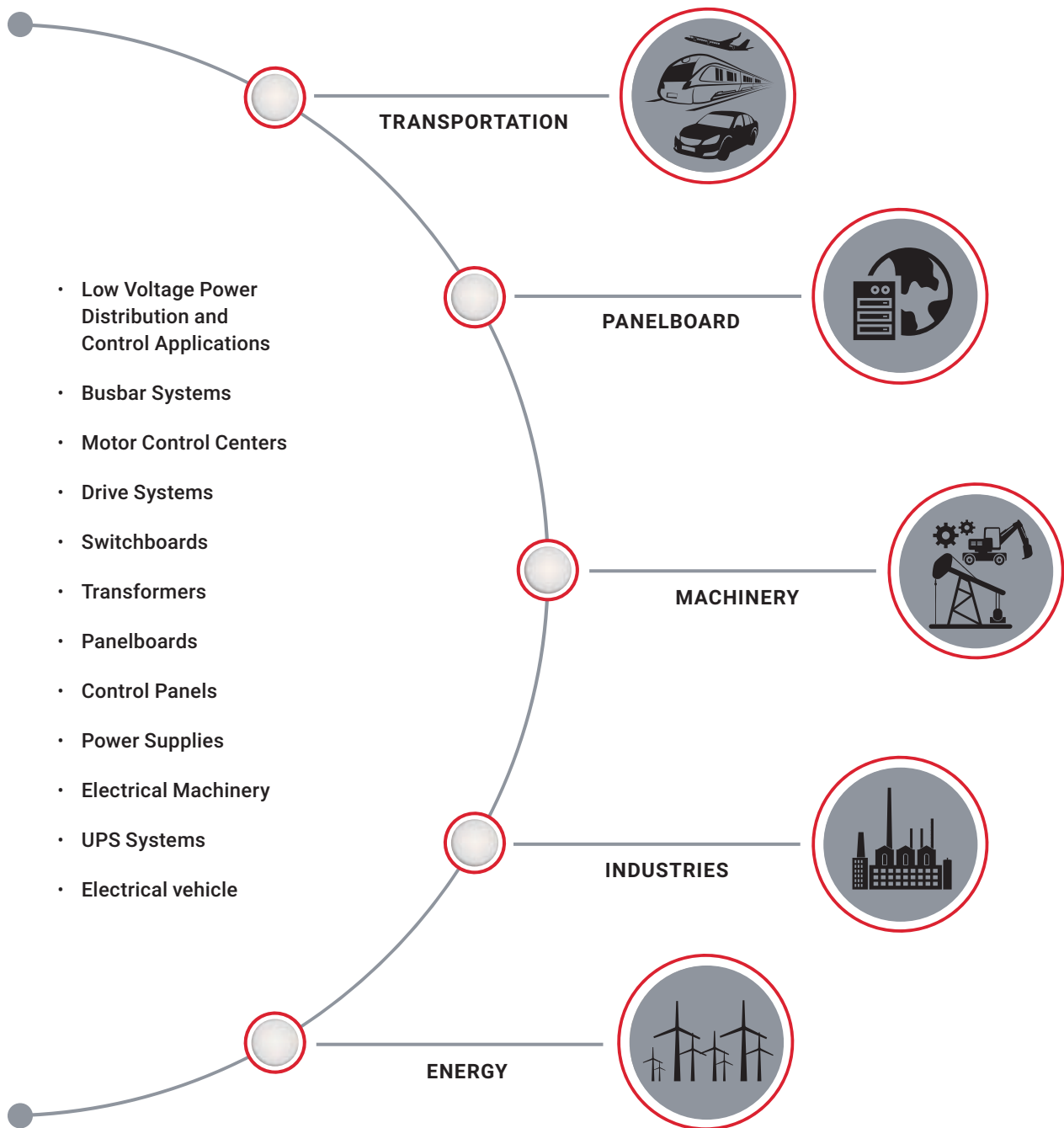



Busbar and active electrical component connection (Example: circuit breaker, contactor) including the most compact components on the market

IBS & IBSB Advanced Applications



Technical Specifications

IBS & IBSB Advanced	
Material	Electrolytic copper Cu-ETP 99,9% purity Thermoplastic Elastomer
Wire Diameter	0,15 mm
Finish	Tinned palm
Maximum resistivity at 20°C	0.017241 ohms.mm ² / m
Dielectric Strength	20 kV/mm
Flammability Rating	UL® 94V-0 IEC® 60695-2-12 (Glow Wire Test 960 °C)
Halogen Free Rating	UL® 2885 IEC® 60754-1 IEC® 62821-2
Low Smoke Rating	UL® 2885 IEC® 61034-2 ISO 5659-2
Typical Insulation Elongation	> 500%
Typical Insulation Thickness	1.8 mm (0,070 inches)
Nominal Voltage	IEC/UL 758: 1,000 VAC; 1,500 VDC UL 67: 600 VAC/DC
Working Temperature	-50 to 115 °C (-58 to 239°F)
UV Rating	UL 2556 and UL 854
Certification Details	UL® 67 UL® 758 CSA 90005
Complies With	IEC® 60695-2-12 (Glow Wire Test 960 °C) IEC® 61439.1 IEC® 61439.1 Class II CE RoHS EN 45545 : HL2 classification Marine and Offshore : ABS, DNV-GL, Bureau Veritas
	        



See our web site, www.erico.com for last data update and certification documents

Dimensions and Packing unit

Part Number	Article Number	Cross Section (mm ²)	Conductor Width (mm)	Conductor Thickness (mm)	L (mm)	A (mm)	B (mm)	C (mm)	D (mm)	HS1 (mm)	HS2 (mm)	
IBSBADV25-230	534400	25	12	2.8	230	7.5	7.5	18	9	6.5	6.5	10
IBSBADV25-330	534401	25	12	2.8	330	7.5	7.5	18	9	6.5	6.5	10
IBSBADV25-430	534402	25	12	2.8	430	7.5	7.5	18	9	6.5	6.5	10
IBSBADV25-530	534403	25	12	2.8	530	7.5	7.5	18	9	6.5	6.5	10
IBSBADV25-630	534404	25	12	2.8	630	7.5	7.5	18	9	6.5	6.5	10
IBSBADV25-830	534405	25	12	2.8	830	7.5	7.5	18	9	6.5	6.5	10
IBSBADV25-1030	534406	25	12	2.8	1030	7.5	7.5	18	9	6.5	6.5	10
IBSADV25-230	534500	25	20	1.9	230	10	12	25	6	8.5	10.5	10
IBSADV25-330	534501	25	20	1.9	330	10	12	25	6	8.5	10.5	10
IBSADV25-430	534502	25	20	1.9	430	10	12	25	6	8.5	10.5	10
IBSADV25-530	534503	25	20	1.9	530	10	12	25	6	8.5	10.5	10
IBSADV25-630	534504	25	20	1.9	630	10	12	25	6	8.5	10.5	10
IBSADV25-830	534505	25	20	1.9	830	10	12	25	6	8.5	10.5	10
IBSADV25-1030	534506	25	20	1.9	1030	10	12	25	6	8.5	10.5	10
IBSBADV50-230	534407	50	20	3	230	9	11	27	9	8.5	10.5	10
IBSBADV50-330	534408	50	20	3	330	9	11	27	9	8.5	10.5	10
IBSBADV50-430	534409	50	20	3	430	9	11	27	9	8.5	10.5	10
IBSBADV50-530	534410	50	20	3	530	9	11	27	9	8.5	10.5	10
IBSBADV50-630	534411	50	20	3	630	9	11	27	9	8.5	10.5	10
IBSBADV50-830	534412	50	20	3	830	9	11	27	9	8.5	10.5	10
IBSBADV50-1030	534413	50	20	3	1030	9	11	27	9	8.5	10.5	10
IBSADV50-230	534507	50	20	3.8	230	12	12	25	7.5	10.5	10.5	10
IBSADV50-330	534508	50	20	3.8	330	12	12	25	7.5	10.5	10.5	10
IBSADV50-430	534509	50	20	3.8	430	12	12	25	7.5	10.5	10.5	10
IBSADV50-530	534510	50	20	3.8	530	12	12	25	7.5	10.5	10.5	10
IBSADV50-630	534511	50	20	3.8	630	12	12	25	7.5	10.5	10.5	10
IBSADV50-830	534512	50	20	3.8	830	12	12	25	7.5	10.5	10.5	10
IBSADV50-1030	534513	50	20	3.8	1030	12	12	25	7.5	10.5	10.5	10
IBSBADV70-230	534414	70	20	4.3	230	9	11	27	11	8.5	10.5	10
IBSBADV70-330	534415	70	20	4.3	330	9	11	27	11	8.5	10.5	10
IBSBADV70-430	534416	70	20	4.3	430	9	11	27	11	8.5	10.5	10
IBSBADV70-530	534417	70	20	4.3	530	9	11	27	11	8.5	10.5	10
IBSBADV70-630	534418	70	20	4.3	630	9	11	27	11	8.5	10.5	10
IBSBADV70-830	534419	70	20	4.3	830	9	11	27	11	8.5	10.5	10
IBSBADV70-1030	534420	70	20	4.3	1030	9	11	27	11	8.5	10.5	10
IBSBADV100-230	534421	100	24	5	230	9	11	31	13	8.5	10.5	10
IBSBADV100-330	534422	100	24	5	330	9	11	31	13	8.5	10.5	10
IBSBADV100-430	534423	100	24	5	430	9	11	31	13	8.5	10.5	10
IBSBADV100-530	534424	100	24	5	530	9	11	31	13	8.5	10.5	10
IBSBADV100-630	534425	100	24	5	630	9	11	31	13	8.5	10.5	10
IBSBADV100-830	534426	100	24	5	830	9	11	31	13	8.5	10.5	10
IBSBADV100-1030	534427	100	24	5	1030	9	11	31	13	8.5	10.5	10
IBSBADV120-230	534428	120	32	4.4	230	11	11	39	12	10.5	10.5	2
IBSBADV120-330	534429	120	32	4.4	330	11	11	39	12	10.5	10.5	2
IBSBADV120-430	534430	120	32	4.4	430	11	11	39	12	10.5	10.5	2
IBSBADV120-530	534431	120	32	4.4	530	11	11	39	12	10.5	10.5	2
IBSBADV120-630	534432	120	32	4.4	630	11	11	39	12	10.5	10.5	2
IBSBADV120-830	534433	120	32	4.4	830	11	11	39	12	10.5	10.5	2
IBSBADV120-1030	534434	120	32	4.4	1030	11	11	39	12	10.5	10.5	2
IBSBADV185-330	534435	185	32	7.1	330	12	14	39	16	10.5	12.5	2
IBSBADV185-430	534436	185	32	7.1	430	12	14	39	16	10.5	12.5	2
IBSBADV185-530	534437	185	32	7.1	530	12	14	39	16	10.5	12.5	2
IBSBADV185-630	534438	185	32	7.1	630	12	14	39	16	10.5	12.5	2
IBSBADV185-830	534439	185	32	7.1	830	12	14	39	16	10.5	12.5	2
IBSBADV185-1030	534440	185	32	7.1	1030	12	14	39	16	10.5	12.5	2
IBSBADV240-330	534441	240	32	9.2	330	12	14	39	18.5	10.5	12.5	2
IBSBADV240-430	534442	240	32	9.2	430	12	14	39	18.5	10.5	12.5	2
IBSBADV240-530	534443	240	32	9.2	530	12	14	39	18.5	10.5	12.5	2
IBSBADV240-630	534444	240	32	9.2	630	12	14	39	18.5	10.5	12.5	2
IBSBADV240-830	534445	240	32	9.2	830	12	14	39	18.5	10.5	12.5	2
IBSBADV240-1030	534446	240	32	9.2	1030	12	14	39	18.5	10.5	12.5	2

*Typical values

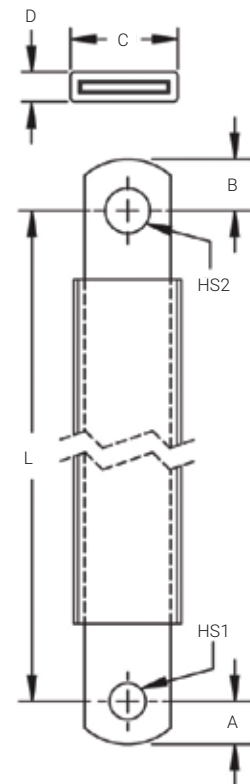

IBS & IBSB Advanced Selection

SELECTION OF IBS & IBSB ADVANCED ACCORDING TO THE INTERNAL TEMPERATURE OF THE PANEL

The air temperature around the conductor is a very important parameter when sizing a conductor. Factors such as convection type, protection level of enclosure, temperature rise and more all affect the selection of conductor size.

Below is an ampacity table under different temperature rise. A lower temperature rise may be used when the ambient temperature is higher than usual. It is recommended the maximum temperature rise does not exceed 50°C for a normal application when using IBS & IBSB Advanced.

Generally, 50°C is chosen as the default temperature rise considering the ambient temperature inside the panel is below 40°C. But when the connected part is an electrical component which may dissipate heat (for example circuit breaker) or the ventilation inside the enclosure is not efficient, it may be necessary to choose lower temperature rise.

HOW TO SIZE CONDUCTORS.

The chart below demonstrates the general steps to determine IBS & IBSB Advanced size.

Temperature rise (ΔT)

- Temperature rise (ΔT)
- Application
- Ambient temperature
- Max temp of the insulation

Service conditions

- Altitude
- Frequency
- Corrosion / Environment

Determine conductor size

- IEC or UL application
- Rated current
- Preferred dimension
- N° of bar per phase
- Safety margin
- Connected device characteristics

TEMPERATURE RISE OF THE CONDUCTOR.

Temperature rise of the conductor (ΔT) = Temperature of the conductor – Internal temperature of the panel.

Temperature rise of conductor = $T_2 - T_1 = \Delta T$ (C°)

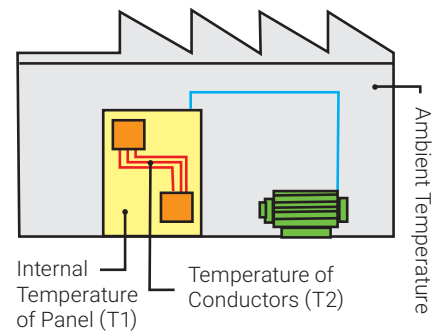

Ex: For a requested current of 630A, with: $T_1 = 40^\circ\text{C}$ and $T_2 = 90^\circ\text{C}$

1. $\Delta T = 90 - 40 = 50^\circ\text{C}$
2. In the ΔT 50°C column, find the closest current value to 630A.

Result: IBSB Advanced 240 mm² – 718A (IEC & UL).

DERATING FACTOR TO USE FOR IBS & IBSB ADVANCED IN PARALLEL

When using two or three IBS & IBSB Advanced in parallel for the same phase, use the current coefficient showed on the next IEC & UL ampacities table:

Example: IBSB Advanced 240 mm² – $\Delta T = 50^\circ\text{C}$: 718 A (IEC & UL)

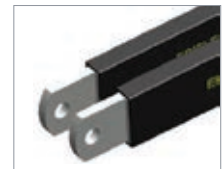

- 2 Braids in parallel > 718 A x 1,6 = 1149 A
- 3 Braids in parallel > 718 A x 2 = 1436 A

See Table next page for IBS & IBSB Advanced current coefficient with two or three conductors per phase, in the above shown orientation.



IBS & IBSB Advanced Current/Ampacities



Insulated Braided conductor type	Cross Section mm ² (kcmil)	Maximum Ampacity Ratings							Current Coefficient	
		ΔT 30° C (A)	ΔT 40° C (A)	ΔT 45° C (A)	ΔT 50° C (A)	ΔT 55° C (A)	ΔT 60° C (A)	ΔT 70° C (A)		
IBSB ADV 25	25 (49.34)	116	134	142	150	157	164	177	1.6	2
IBS ADV 25	25 (49.34)	137	158	167	177	185	193	209	1.6	2
IBS ADV 50 IBSB ADV 50	50 (98.68)	213	246	260	274	288	301	325	1.6	2
IBSB ADV 70	70 (138.15)	226	261	277	291	306	319	345	1.6	2
IBSB ADV 100	100 (197.35)	298	344	365	385	404	422	456	1.6	2
IBSB ADV 120	120 (236.82)	363	419	444	468	491	513	554	1.6	2
IBSB ADV 185	185 (365.1)	416	480	509	537	563	588	635	1.6	2
IBSB ADV 240	240 (473.65)	556	642	681	718	753	786	849	1.6	2

Admissible currents: This table indicates the temperature rise produced by chosen current in the given section. This calculation does not take into account the heat dissipation from the switch gear.

Follow the instructions provided by the electrical device manufacturer.

Temperature rise of the conductor (ΔT) = Temperature of the conductor – Internal temperature of the panel.

IBS & IBSB Advanced Cable Cross Section Comparison

METRIC

Typical Application Current Rating	H07VK Cable	IBS/IBSB Advanced	% cross section reduction
	Cross section mm ²	Cross section mm ²	Average
125 A	35	25	-29%
160 A	50 – 70	25	-50%
250 A	95 – 120	50	-47%
300 A	120	70 – 100	-29%
320 A	150	100	-33%
350 A	185	100	-46%
400 A	185 – 95x2	120	-35%
500 A	240	185	-23%
630 A	300 – 150x2	240	-20%
700 A	185x2 – 150x3	240	-35%

Cable cross section according to IEC 60228 – Table 2 (stranded conductors 90°C insulation)

IMPERIAL

Typical Application Current Rating	2017 NEC, Table B.310.15(B)(2)(1), 75 C Column @ 45C temperature rise	IBS/IBSB Advanced	% cross section reduction
	AWG / kcmil	Cross section mm ²	Average
125 A	1/0	25	-53%
160 A	2/0	25	-63%
250 A	250	50	-61%
300 A	350	70 – 100	-52%
320 A	400	100	-51%
350 A	500	100	-60%
400 A	600	120	-61%
500 A	900	185	-59%
630 A	1500	240	-68%
700 A	2000	240	-76%

Cable cross section according to 2017 NEC, Table B.310.15(B)(2)(1), 75 C Column @ 45C temperature rise

Skin Effect on Alternative

Skin Effect is the tendency of an alternating electric current (AC) to become distributed within a conductor such that the current density is largest near the surface of the conductor and decreases with greater depths in the conductor.

The skin effect is due to opposing eddy currents induced by the changing magnetic field resulting from the alternating current. At 60 Hz in copper, the skin depth is about 8.5 mm (for a round conductor).

The nVent ERIFLEX IBS & IBSB Advanced and its rectangular geometry do not have these limitations and have a low skin effect ratio.

Skin effect is a phenomenon which has the effect of concentrating the current on the perimeter of the conductor. Its importance depends on frequency, the resistance of the material and the shape of the conductor.

The ratio of width/thickness for IBS & IBSB Advanced is greater than cables and allows for having a good skin effect.

For the same cross section area, IBS & IBSB Advanced has a greater surface area for cooling in addition to having a more uniform current density.

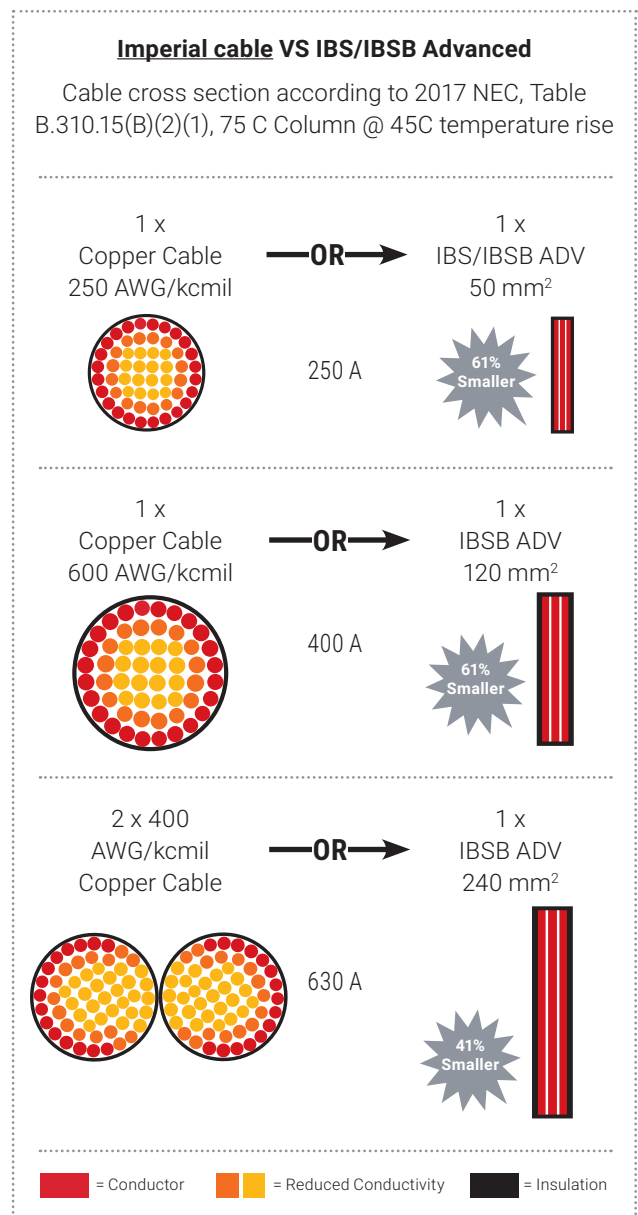
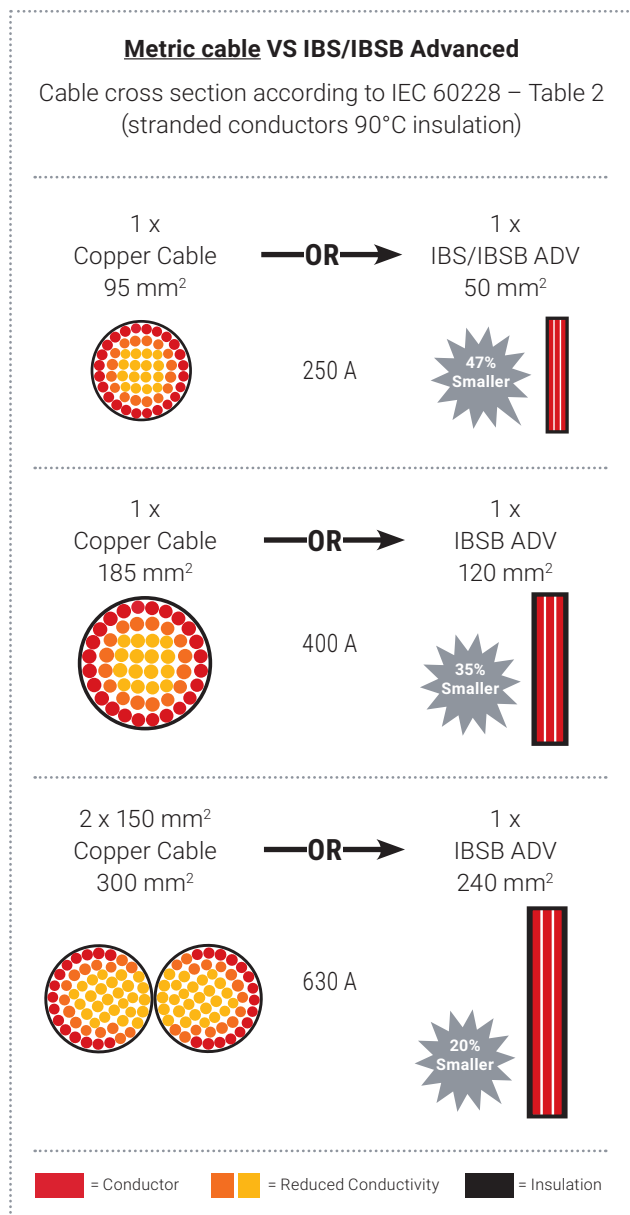

Skin Effect and Frequency

SKIN EFFECT INCREASES ALONG WITH FREQUENCY.

The current ratings of nVent ERIFLEX IBS & IBSB Advanced as published in our catalog and web site are based on operating frequency up to 100HZ. Due to all copper conductors have higher impedance at higher frequencies; a de-rating factor should be applied for a particular application operated at higher frequencies. However, the rectangular cross-section of IBS & IBSB Advanced reduces this effect as compared to cables with round cross-section.

CURRENT PENETRATION DEPTH DATA:

- 1 Hz = 64mm
- 50 Hz = 9,28mm
- 250 Hz = 4,15mm
- 500 Hz = 2,93mm
- 1000 Hz = 2,07mm

An ampacity derating needs to be applied for frequencies higher than 100 Hz. Please refer to the below table

Insulated Braided conductor type	Cross Section mm ² (kcmil)	De-Rating Coefficient								
		Frequency (Hz.)								
		DC Current and up to 60 Hz	100 Hz	500 Hz	1000 Hz	2000 Hz	4000 Hz	6000 Hz	8000 Hz	10000 Hz
IBSB ADV 25	25 (49.34)	1	1	1.00	1.00	1.00	1.05	1.16	1.25	1.32
IBS ADV 25	25 (49.34)	1	1	1.00	1.00	1.00	1.00	1.00	1.01	1.07
IBS ADV 50 IBSB ADV 50	50 (98.68)	1	1	1.00	1.00	1.18	1.40	1.55	1.67	1.76
IBSB ADV 70	70 (138.15)	1	1	1.06	1.27	1.51	1.79	1.98	2.13	2.25
IBSB ADV 100	100 (197.35)	1	1	1.06	1.27	1.51	1.79	1.98	2.13	2.25
IBSB ADV 120	120 (236.82)	1	1	1.02	1.22	1.45	1.72	1.91	2.05	2.17
IBSB ADV 185	185 (365.1)	1	1	1.23	1.47	1.75	2.08	2.30	2.47	2.61
IBSB ADV 240	240 (473.65)	1	1	1.23	1.47	1.75	2.08	2.30	2.47	2.61



The formula below specifies how the de-rating factors on the table should be used:

$$I_f \cong \frac{I_{50 \text{ Hz}}}{K_f}$$

Power Dissipation

POWER DISSIPATION

Joule heating, also known as ohmic heating and resistive heating, is the process by which the passage of an electric current through a conductor produces heat.

The table below provides the Power dissipation generated by nVent ERIFLEX IBS & IBSB Advanced at Typical Application current rating with conductor temperature at 85°C.

The values in the table are in Watt per phase and per available length.

If IBS & IBSB Advanced is not used at a typical application current rating but within higher or lower value, you can use our ERIFLEX online software to determine the power losses at your specific current Rating:



<https://eriflex-configurator.nvent.com/eriflex/>

Typical Application Current Rating	Insulated Braided conductor type	Cross Section mm ² (kcmil)	Power dissipation at Typical Application Current Rating (W/phase) @ 85°C						
			Length (mm)						
			230	330	430	530	630	830	1030
160 A	IBSB ADV 25 IBS ADV 25	25 (49.34)	5	7	9	12	14	19	23
250 A	IBS ADV 50 IBSB ADV 50	50 (98.68)	6	8	11	14	17	23	28
300 A	IBSB ADV 70	70 (138.15)	6	9	12	15	18	24	30
350 A	IBSB ADV 100	100 (197.35)	5	8	11	14	17	22	28
400 A	IBSB ADV 120	120 (236.82)	6	9	12	15	18	24	30
500 A	IBSB ADV 185	185 (365.1)	–	9	12	15	18	25	31
630 A	IBSB ADV 240	240 (473.65)	–	11	15	19	23	31	38

Short-Circuit

Electromagnetic Forces (Ipk) are induced in conductors by the currents flowing through them. When parallel conductors are longer compared to the distance between them, the force will be evenly distributed along the conductors. The force is attractive when the currents in the two conductors have the same direction resulting in a “pull” mechanical effect. When the directions of the currents are opposite, the forces are repulsive resulting into a “push” mechanical effect.

A **Thermal Phenomenon (Icw)** is created by the ampacity carried in the conductive parts. The increase of conductor temperature is linked to the resistance of the conductor material and cross section, ampacity and duration.

This phenomenon may destroy the device or the conductor insulation if the selection is not properly done. The device or conductor characteristics are quantified by a maximum admissible ampacity (Icw).



Before Short-circuit test



After Short-circuit test

Insulated Braided conductor type	IBSB ADV 25 IBS ADV 25	IBS ADV 50 IBSB ADV 50	IBSB ADV 70	IBSB ADV 100	IBSB ADV 120	IBSB ADV 185	IBSB ADV 240
Cross Section mm ²	25	50	70	100	120	185	240
Short-Circuit withstand Strength (Ipk)							
Design Upstream protection Device Cut off current limited peak	25	70	70	70	70	70	105
Energy dissipation Joule integrale, I ² t [A ² s]	2.28E+07	8.17E+07	1.00E+08	3.30E+08	3.30E+08	8.78E+08	1.52E+09
Thermal short-circuit strength (Icw)							
kA (0,2 second)	10.7	20.2	22.4	40.6	40.6	66.3	87.2
kA (0,5 second)	6.7	12.8	14.1	25.7	25.7	41.9	55.2

The conductors on the supply side (upstream) of the functional unit can be rated based on the load side (downstream) from a short-circuit perspective (IEC 61431.1-§8.6.1) with no specific requirement for IBS/IBSB Advanced (see page 18 class II).



nVent ERIFLEX IBS & IBSB Advanced UL & CSA Certification

QUALITY VALIDATED BY TESTS & CERTIFICATIONS

UL 67 & UL 891 tests (UL file QEUY2/8. E125470).

In UL file QEUY2/8. E125470, IBS & IBSB Advanced are UL Recognized per ANSI/UL 67 "Panelboards", ANSI/UL 891 "Switchboards", CSA C22.2 No. 29 (Panelboards), and CSA C22.2 No. 244 (Switchboards).

UL 758 tests (UL file AVLV2/8 .E316390).

In UL file AVLV2/8 .E316390, IBS & IBSB Advanced are UL Recognized per ANSI/UL 758 "Appliance Wiring Material", under style 11715 (1000VAC/1500VDC) and CSA C22.2 No. 210 (Appliance Wiring Material).

CSA also certified IBS & IBS Advanced per CSA C22.2 No. 210 (1000 VAC).

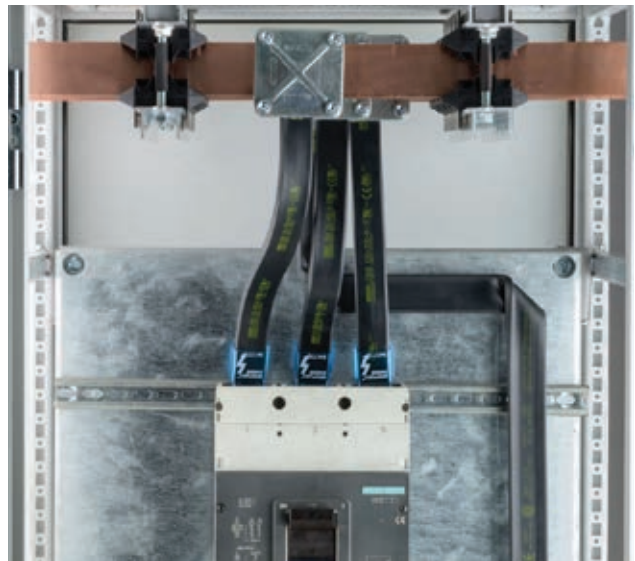

In order to be recognized, these products have to undergo a series of rigorous tests that will assess of their performance in a lab setting reproducing the working environment of a real panelboard or switchboard.



Temperature/current test



Flexibility test



Dielectric voltage-withstand test



Deformation test



Detailed examination



Vertical flame test



Physical properties



VW-1 flame test



Cold bend test



Insulation resistance test



Heat shock test



Temperature correction factor

Flexibility and Bending Radius Comparison with Cable

Bend radius is the minimum radius a pipe, cable, wire, sheet, cable, tube or hose can bend without damaging it. The minimum bend radius is the radius below which an object should not be bent.

The smaller the radius, the greater the flexibility of the material.

Due to the IBS & IBSB Advanced construction, the flexibility allows for increased design flexibility. IBS & IBSB Advanced is manufactured with multiple 0.15 mm wires and require less wire bending space than cable due to high flexibility and have no strict minimum bending radius constraint. It is possible to realize compact power connection and reduce the size and price of the enclosure and by consequence, the enclosure ground surface.

To determine how tight a given cable can be bent without damage, use the chart below to obtain the multiplier based on cable type. Note that this table is an overview. Cable manufacturer data should be checked.

Type	Min Bending Radius
Single or multiple conductor cables – no metallic shielding	8 x the overall cable diameter
Single conductor cable – with metallic shielding	12 x the overall cable diameter
Multiple conductor cables – with individually shielded conductors	12 x the individual cable diameter or 7 x the overall cable diameter (whichever is greater)

Table from NEC Articles 300-34, 334-11 & 336-16, as well as Appendix H of ICEA S-66-524 and ICEA S-68-516

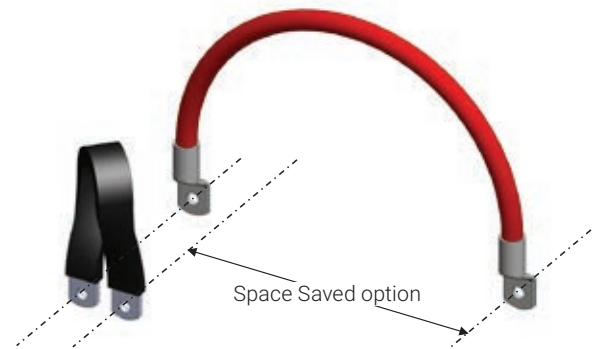
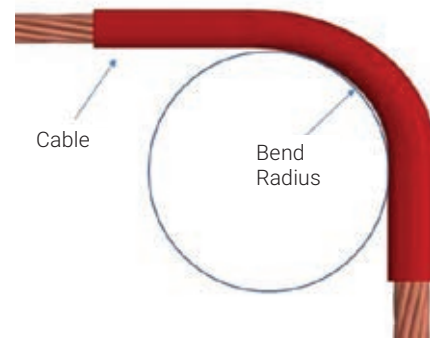

Class II Insulation

The nVent ERIFLEX IBS & IBSB Advanced have Class II insulation certification, according to IEC 61439-1 due to:

- High dielectric strength (>20KV/mm)
- High mechanical resistance (IK 09)
- High temperature resistance (Glow wire test 960°C)

This certification allows:

- Touching and fixing directly to metal parts (without sharp edges) permitted (no clearance distance needed)
- Max operating current: up to 100% of the conductor maximum rated temperature (80% without Class II).



TABLE 4 – CONDUCTOR SELECTION AND INSTALLATION REQUIREMENTS (8.6.4) FROM IEC 61 439-1

Insulation none Class II compliant are considered basic insulation. Additional requirements are mandatory.



IBS & IBSB Advanced are considered as a very high mechanical strength material insulation after test (class II). It gives the advantage of no additional requirements.



Type of conductor	Requirements
Bare conductors or single-core conductors with basic insulation, for example cables according to IEC 60227-3	Mutual contact or contact with conductive parts shall be avoided, for example by use of spacers
Single-core conductors with basic insulation and a maximum permissible conductor operating temperature of at least 90 °C, for example cables according to IEC 60245-3, or heat-resistant thermoplastic (PVC) insulated cables according to IEC 60227-3	Mutual contact or contact with conductive parts is permitted where there is no applied external pressure. Contact with sharp edges shall be avoided. These conductors may only be loaded such that an operating temperature of 80 % of the maximum permissible conductor operating temperature is not exceeded
Conductors with basic insulation, for example cables according to IEC 60227-3, having additional secondary insulation, for example individually covered cables with shrink sleeving or individually run cables in plastic conduits	No additional requirements
Conductors insulated with a very high mechanical additional requirements strength material, for example Ethylene Tetrafluoro Ethylene (ETFE) insulation, or double-insulated conductors with an enhanced outer sheath rated for use up to 3 kV, for example cables according to IEC 60502	
Single or multi-core sheathed cables, for example cables according to IEC 60245-4 or IEC 60227-4	

Class II Insulation

Chapter 8.6 of internal electricals and connections of IEC 61439-1 provides strict rules about conductor selection and installation to prevent short-circuit and its potential consequences. Table 4 defines the requirement of a bare conductor, basic insulated conductor and a reinforced/double insulated conductor (class II) as a conductor that applies in a switchboard.



The advantage of using a reinforced/double insulated conductor is that the table 4 requires "no additional requirement":

BARE CONDUCTOR:

- Clearance distance and supports / insulators.
- Example: solid bars

BASIC INSULATION CONDUCTOR:

- No contact or fixing directly to any metal parts
- Operating temperature 80% of the maximum allowed by the conductor to prevent the thermal short-circuit damages.

Example: conductors with shrinkable sleeve, one single core cables.

CLASS II CONDUCTOR:

- Touching and fixing directly to metal parts permitted (no clearance distance needed).
- 100% Max operating temperature 115°C for IBS & IBSB Advanced.

If any conductors do not fulfil the requirements, the circuit is subject to additional short-circuit tests (10.11).

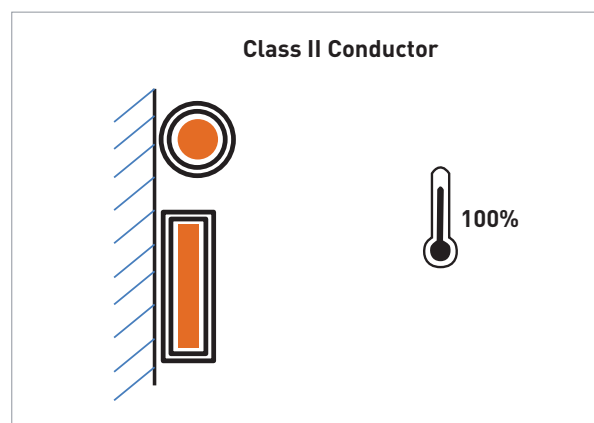
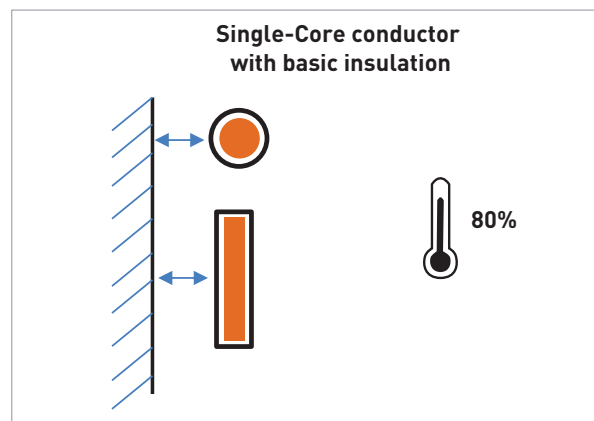

Altitude Effect

ALTITUDE

For conductors to be used at altitude exceeding 2000 m, it's necessary to take the reduction of the dielectric strength and the cooling capacity affected by the air density into account. The air cooling capability drops along with the altitude increasing, meaning a de-rating factor should be used as the altitude exceeds 2000m. The table below abstracted from DIN 43671 may be used as a reference for IBS & IBSB Advanced.

Altitude (m)	Derating factor	
	Ampacities (A)	Voltage (V)
> 2000	0.99	0.99
> 3000	0.96	0.96
> 4000	0.9	0.8

Low Smoke (LS)

LOW SMOKE (LS) MATERIAL OFFERS:

- Improved visibility conditions in case of fire due to lower density of smoke
- Ability to easily locate the emergency exit
- Rescue workers the ability to assess an emergency situation
- Less damage to electrical equipment

LOW SMOKE (LS) IBS & IBSB ADVANCED IS TESTED AND COMPLIES WITH:

- IEC® 61034-2 (Measurement of smoke density of cables burning under defined conditions).
- IEC® 60695-6-2 (Fire hazard testing – Part 6-2: Smoke obscuration – Summary and relevance of test methods).
- ISO 5659-2 (determination of the optical density of smoke produced from a horizontally positioned test specimen subjected to a specific thermal radiation in a sealed chamber).
- UL® 2885 (Outline of Investigation for Acid Gas, Acidity and Conductivity of Combusted Materials).

IBS & IBSB Advanced are Low Smoke conductors.



Halogen-Free (HF)

Halogen Free (HF) material does not contain:

- Fluorine
- Chlorine => (used for PVC)
- Bromine
- Iodine
- Astatine

HALOGEN FREE (HF) MATERIAL OFFERS:

- Better environmental impact
- Reduction in the quantity of toxic smoke for people
- Reduction of corrosive smoke from electrical equipment

HALOGEN FREE (HF) IBS & IBSB ADVANCED IS TESTED AND COMPLIES WITH:

- IEC® 60754-1 (Test on gases evolved during combustion of materials from cables – Part 1: Determination of the halogen acid gas content)
- IEC® 62821-2 (Electric cables – Halogen-free, low smoke, thermoplastic insulated and sheathed cables of rated voltages up to and including 450/750 V)
- UL® 2885 (Outline of Investigation for Acid Gas, Acidity and Conductivity of Combusted Materials)

IBS & IBSB Advanced are Halogen-Free conductors.

Flame Retardant (FR)

Flame Retardant (FR) material, also called Self Extinguishing material, has the effect of slowing down the spread of fire and according to the international standards such as:

- UL 94V-0
- IEC 60695-2 (Glow Wire test)

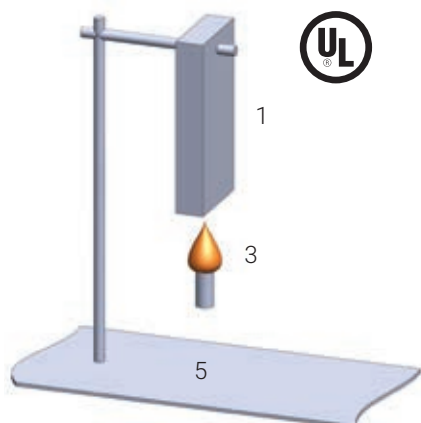
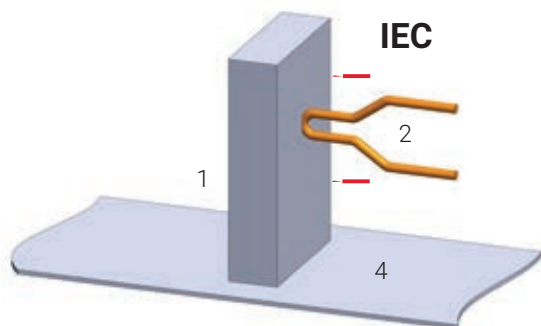

1. Specimen
2. Glow wire
3. Flame
4. Tissue
5. Cotton

UL94 – TABLE 8.1

Material Classifications			
Criteria Conditions	94V-0	94V-1	94V-2
Afterflame time for each individual specimen t1 or t2	≤10s	≤30s	≤30s
Total afterflame time for any condition (t1 plus t2 for the 5 specimens)	≤50s	≤250s	≤250s
Afterflame plus afterglow time for each individual specimen after the second flame application (t2+t3)	≤30s	≤60s	≤60s
Afterflame or afterglow of any specimen up to the holding clamp	No	No	No
Cotton indicator ignited by flaming particles or drops	No	No	Yes

IBS & IBSB Advanced have a flammability rating of UL 94V-0. In addition, IBS & IBSB Advanced passed the IEC 60695-2 (Glow Wire test) at the highest possible level (960°C) with burning or glow time ≤ 30s and with the paper and wood undamaged during test sequence.

EN 45545-2 Fire Testing to Railway Components

EN 45545-2 EUROPEAN UNION STANDARD FIRE TESTING TO RAILWAY COMPONENTS

In order to choose the appropriate product for a given application, it is the customer's responsibility to understand the extent of use for the product, as well as the intended final use for the Rolling Stock. Vehicles are classified as: HL1, HL2 or HL3 depending on their time in tunnels and whether they contain sleeper cars. The HL1 classification represents the lowest Hazard Level and HL3 represents the highest. Please refer to EN 45545-2 for further definitions.

This standard provides guidance to quantify the impact of a fire compared with the product requirements classification.

ERIFLEX IBS & IBSB Advanced would fall under the R22 and R23 product requirement sets, depending on their installation location.

There are 3 tests used to establish product performance versus these product requirements:

- Oxygen index to T01 EN ISO 4589-2
- Flue gas density to T 10.03 EN ISO 5659
- Oxygen index to T 12 NF X70-100-1 and -2

Performance requirements on EN 45545-2 for each of these tests are summarized below. Please refer to EN 45545-2 for additional details.

				HL1	HL2	HL3
R22	T01 EN ISO 4589-2 OI	Oxygen Content %	Minimum	28	28	32
	T10.03 EN ISO 5659-2: 25 kWm	Ds max. dimensionless	Maximum	600	300	150
	T12 NF X70-100-1: and -2, 600° C	CI Tnlp dimensionless	Maximum	1.2	0.9	0.75
R23	T01 EN ISO 4589-2: OI	Oxygen Content %	Minimum	28	28	32
	T10.03 EN ISO 5659-2: 25 kWm ²	Ds max. dimensionless	Maximum	–	600	300
	T12 NF X70-100-1 and -2, 600° C	CI Tnlp dimensionless	Maximum	–	1.8	1.5

ERIFLEX IBS & IBSB Advanced Conforms to EN 45545 obtaining an HL2 classification for chapters R22 and R23.



Certifications for Marine & Offshore

WORLDWIDE CERTIFICATION

nVent ERIFLEX is a trusted partner for assistance with designing your electrical cabinet. Our range of world-class certifications include:

- IBS & IBSB Advanced: IEC 61 439-1 and UL 67 / UL 758
- Full nVent ERIFLEX product range is compliant with RoHS and CE

NVENT ERIFLEX ADVANCED TECHNOLOGY CERTIFICATIONS

- Halogen-free: IEC 60754-1 and/or UL 2885 standards
- Low smoke: UL 2885 and IEC 60754-2
- Flame retardant: IEC 60695-2-11 Glow Wire test 960°C and/or UL 94-V0
- UV resistance: UL 2556 and UL 854



NVENT ERIFLEX PRODUCT OFFERING.

SPACE SAVINGS

In the marine and offshore market, space is critical for electrical cabinets and connections. Thanks to the innovative technology from nVent ERIFLEX you can reduce your footprint of your electrical cabinet.



TIME SAVINGS

The design of an electrical panel is important. nVent ERIFLEX helps to simplify the connection with solutions that reduce labor time. Our products are easy to shape and enable more efficient visual inspection.



RELIABILITY

To enhance safety and reliability in enclosed spaces, nVent ERIFLEX has developed a complete and reliable range that uses tinned plate material for better corrosion resistance. Additionally, our unique products help provide better access and improved vibration resistance.

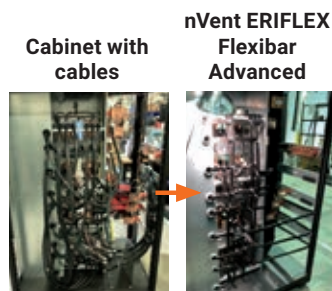

SAFER SOLUTIONS

Catering to the unique needs of the marine and offshore market, the latest generation of nVent ERIFLEX insulation material combines the following features:

- Low smoke, halogen-free, flame retardant
- High temperature resistant
- Tin-plated

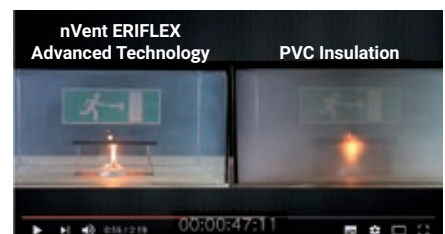

Marine & Offshore Certifications

IBS & IBSB Advanced



Integral/Solid Palm Technology

INNOVATIVE, STATE-OF-THE-ART MANUFACTURING PROCESS

ERIFLEX has developed a unique, state-of-the-art manufacturing line to solidify directly the palms of IBS & IBSB Advanced Conductor.

The innovative manufacturing process provides an effective electrical contact, due to the integral palms, without the additional need for tin or crimped lugs. This process welds the flexible braid and brings back a solid tinned block as a palm. Unlike traditional press-welded palms processes, nVent ERIFLEX's process is suitable not only for red copper, but also for tinned plated copper. The electrical contact between each wire is optimized.

This nVent ERIFLEX process also helps eliminate moisture issues in the palms. By using crimped lugs in a severe environment, moisture can enter in the lug (often by capillarity) and create corrosion between each wire. After several years, the electrical contact between each wire can deteriorate and alter the electrical conductivity of the equipment. The corrosion in the palm is impossible to remove without changing the element.

This process produces RoHS products; no additional substances are added to the tinned-plated wires during the manufacturing process.

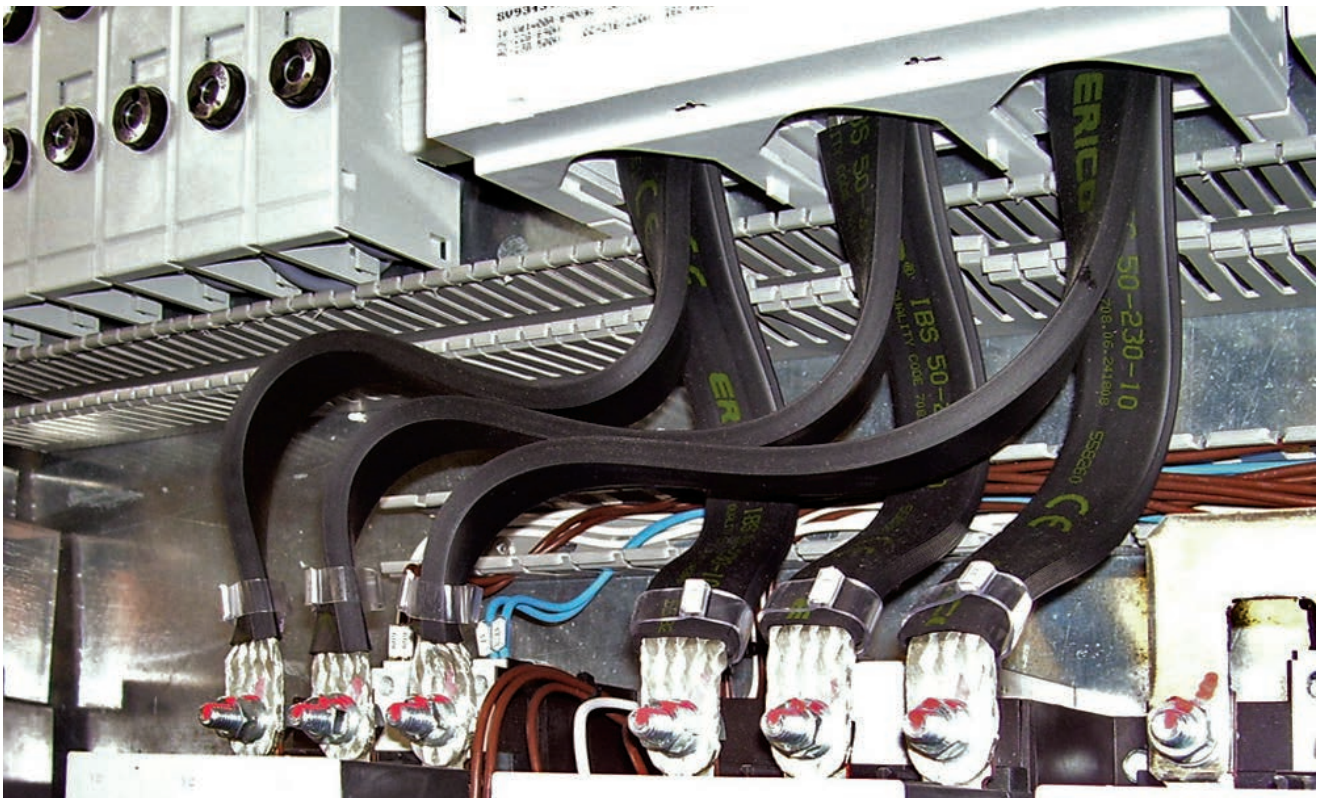

Integral/Solid Palm Tensile Strength

Part of the quality of a power connection is its mechanical resistance or tensile strength. Mechanical effort on the conductor can be extremely important during short-circuit applications and the conductor should resist to those constraints.

STANDARDS THAT PROVIDE GUIDANCE ON TENSILE STRENGTH:

- NFC 20-130 (copper Crimp lug for copper conductors)

- DIN EN 61238-1 (Compression and mechanical connectors for power cables for rated voltages up to 30 kV ($U_m = 36$ kV))
- IEC 760 (Flat, quick-connect terminations)
- UL UL 486A-486B – Wire Connectors (table 27 – Pullout force)

The table below provides the minimum tensile strength resistance from different standards and compares the IBS & IBSB Advanced test results with the UL 486 standard.

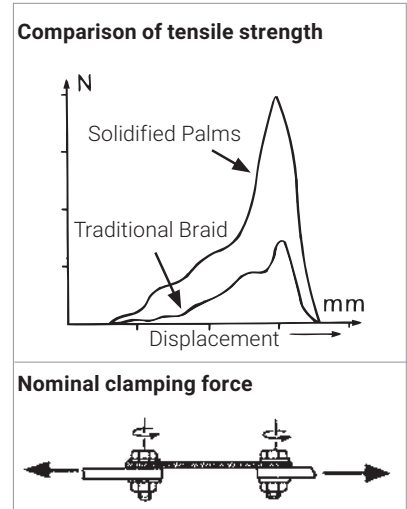

		Minimum tensile strength resistance							IBS & IBSB Advanced		IBS & IBSB Advanced comparison with UL 486A-486B
Conductor cross section (AWG)	Conductor cross section (mm ²)	MIL-T-7928		UL 486A-486B		MIL-DTL-22520G		NFC 20-130	Insulated Braided conductor type	Breaking point (Typical values) N	
AWG	mm ²	Lb	N	Lb	N	Lb	N	N			
4	21.15	400	1780	140	623	400	1780	2171	25 mm ²	4619	741%
2	33.62	550	2448	180	801	550	2448				
1	42.41	650	2893	200	890	650	2893				
0	53.49	700	3115	250	1113	700	3115	3200	50 mm ²	6500	584%
2/0	67.43	750	3338	300	1335	750	3338		70 mm ²	6800	509%
3/0	85.01	825	3671	350	1558						
4/0	107.22	875	3894	450	2003	875	3894	4000	100 mm ²	7800	389%
250	127			500	2225				120 mm ²	7900	355%
300	156			550	2448						
350	177			600	2670				185 mm ²	8100	303%
400	203			650	2893						
500	253			800	3560				240 mm ²	8500	239%

Results: the mechanical resistance of the IBS & IBSB Advanced integral/solid palm provides significantly higher values than the minimum requested by the standards.



Tensile strength test sequence pictures

Integral/Solid Palm Tinned Connection

nVent ERIFLEX IBS & IBSB Advanced manufactured with pure copper and tin protected palm.

TINNED COPPER OFFERS:

- Better corrosion resistance
- Longevity (10 times longer in certain application)
- Higher contact electrical conductivity
- Compliant with a various specifications/countries and niche applications
- Strong performance with less maintenance

SEVERAL UL STANDARDS REQUIRE TINNED COPPER:

- UL67 (Panelboards), Section 10.1.5 – joints must be plated with tin, silver, nickel, or cadmium above 600A
- UL891 (Switchboards), Section 8.8.1.1.5 – joints must be plated with tin, silver, or nickel above 600A
- UL845 (Motor Control Centers), Section 8.2.9 – bolted connection over 600A shall be plated with tin or silver
- UL508A (Industrial Control Panels), Section 29.3.10 – bolted connections over 600A shall be plated with tin, silver, or nickel

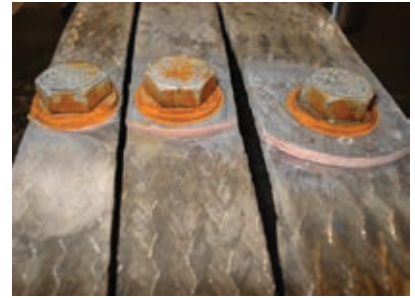

Pictures: Ageing test performed on IBS & IBSB Advanced









- Alternation 105°C / ambient temperature/dumping in the water (6 cycles in 168 hours)
- Minus 25°C, during 150 H, then back to ambient temp.
- Conductivity measurement – Before and after Ageing test.

Results: Stability of the electrical contact

Installation Time and Cost Saving Comparison with Cable & Lug















nVent ERIFLEX IBS & IBSB Advanced is the ideal ready-to-install flexible wire/cable replacement solution. There are no lugs to purchase or install, making connections simpler and faster and eliminates faulty connections due to vibration or fatigue.

IBS & IBSB Advanced is a ready-to-use conductor. There is no need for additional lugs or tools to fabricate the conductor, reducing installation time and cost.

Cable & Lug Solution			Time and cost	IBS & IBSB Advanced Solution
Cable		The wire conductor should be correctly stripped and prepared for the application		Not applicable Ready to use
Adapted Lugs		A crimping lug of good quality designed for this type of connection should always be used		
Certified Tools		A crimping tool of good quality designed for crimping this type of connection should always be used		
Certified Staff		An operator with experience in crimping techniques		
Heat shrink tubing		Appropriate heat shrink tube and heat shrink heater have to be used		
Labor Time				
Result				

IBS & IBSB Advanced is directly connected, thus eliminating the cable lug connection and other source of heating point.

IBS & IBSB Advanced has excellent resistance to vibration and provides no crimping, stripping and a lesser risk of human error.

Cable & Lug Solution			Constraints of stripping and crimping	IBS & IBSB Advanced Solution	
Cable	Crimping			Not applicable Ready to use	
Insulation badly cut		Wire conductor not sufficiently stripped			
Conductor wires damages or cut		Crimping not centralised			
Conductor wires un-stranded		Crimping not centralised			
Conductor wires over-stranded		Inadapted or used die, handles appear			
Insulation particles on bare part of cable		Crimping marks not centred			
Cable insulation damaged					
Result					

How to Achieve a Good Electrical Connection

CONTACT SURFACE CONDITIONS

The surface must be clean and flat but not polished. It must be oxide and grease free.

CLAMPING TORQUE AND HARDWARE ON RIGID COPPER BARS

Use a class 8.8 ZN8C zinc plated bolt or a class coated bichromated bolt (SAE Grade 5) and a "Contact/Belleville" and "Flat" washers tightened with a torque wrench, without lubrication.

Note: Belleville washers also called "Contact Disc Springs"

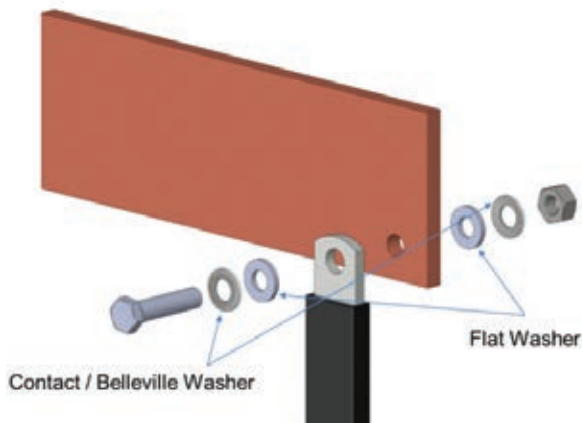

- Class 8.8 ZN8C or SAE Grade 5 hardware can be used except where otherwise designated by the designer of the pieces installed
- Contact/Belleville and Flat washers provide resistance to vibration
- See our web site, www.erico.com to consult our Metric Nuts, bolt and washers contact kits.

Metric (with contact washer)

Bolt size Ø	M6	M8		M10	M12	M14	M16
F (daN)	800	1450		2300	3700	4400	6000
Clamping Torque (Nm)	13	30		60	110	174	274

Imperial (with Belleville washer)

Bolt size Ø	1/4-20	5/16-18	3/8-16	7/16-14	1/2-13	9/16-12	5/8-11
Clamping Torque (foot-pounds)	9	18	31	50	75	110	150



How to Achieve a Good Electrical Connection

CONNECTION AND DISTRIBUTION ON RIGID COPPER BARS

If the busbars have several bars per phase, the connection points must be distributed over the various bars of the same phase. This can be achieved by using copper plates between copper bars or if possible, the nVent ERIFLEX IBS & IBSB Advanced between 2 copper bars. This installation will guarantee a good repartition of current in the busbar.

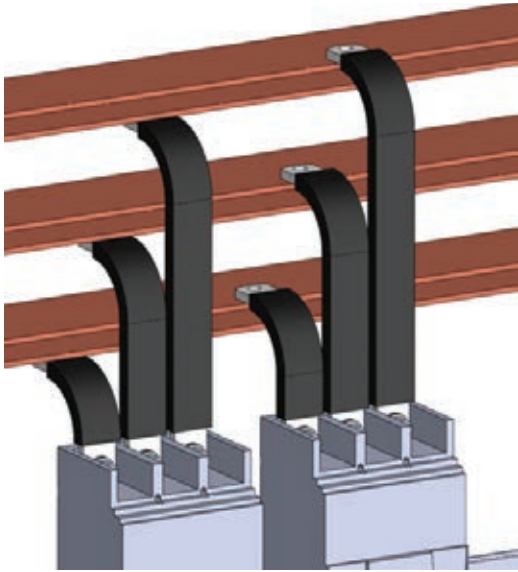

CONNECT ONE OR TWO IBS & IBSB ADVANCED IN PARALLEL:

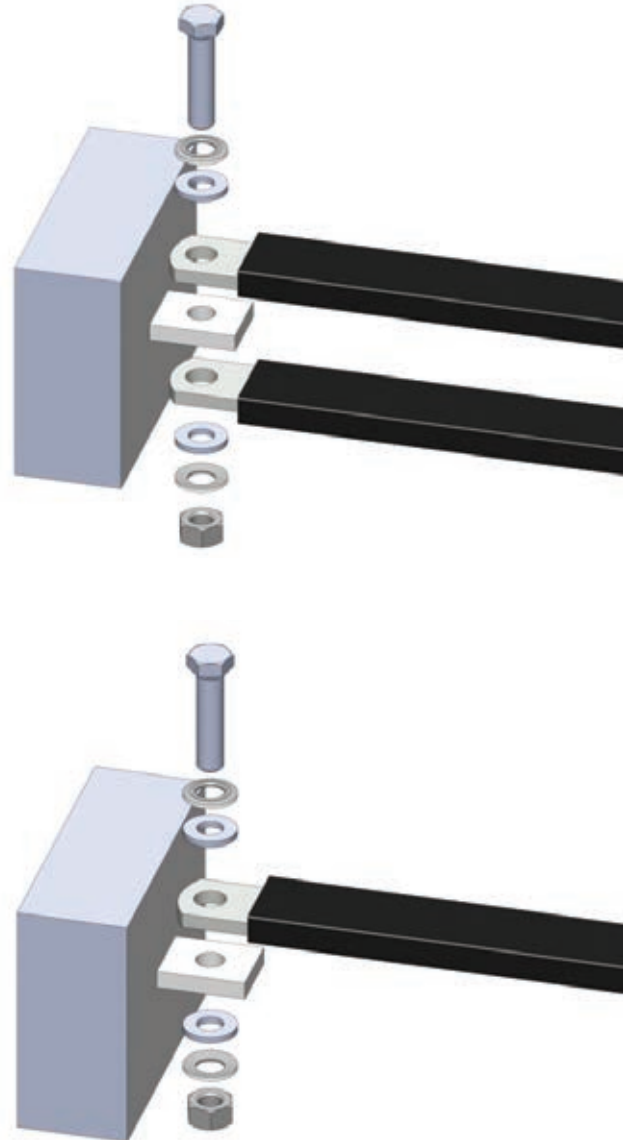

IBS & IBSB ADVANCED CONNECTED TO AN ACTIVE ELECTRICAL DEVICE:

- Use the basic hardware delivered with the device and add a flat washer if not provided.
- Apply the tightening torque specified in the device manual.

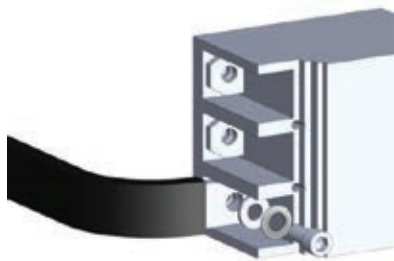

nVent ERIFLEX IBS & IBSB Advanced Connection on MCCB

IDEAL CONNECTION FOR MOLDED CASE CIRCUIT BREAKERS

The IBS & IBSB Advanced range can be used as an alternative to cable for all low-voltage applications. It is suitable and connectable for molded case circuit breaker ranges, including most compact breakers on the market. From 80A up to 630A circuit breakers, you can directly connect the IBS & IBSB Advanced on the front access terminal breaker without additional accessories, such as angular connectors, spreaders, ring terminal connectors or extenders. No lugs, cutting, stripping, or crimping is necessary.

Simple, quick, ready to use!

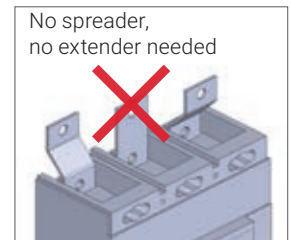
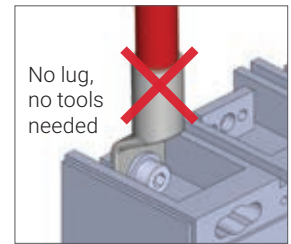
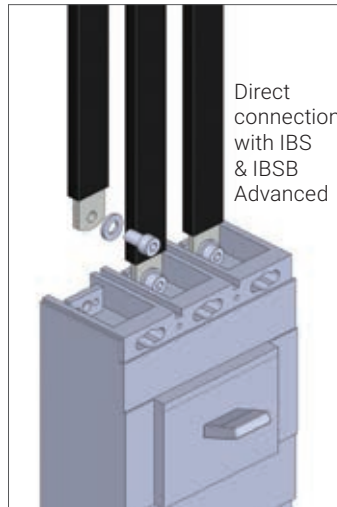

nVent ERIFLEX IBS & IBSB Advanced Connection on MCCB

The below table provides some guidance regarding possible IBS & IBSB Advanced cross section to use for MCCB (Molded Case Circuit Breaker).

MCCB from this list are:

- IEC and/or UL Version
- Front access connection, without accessory
- Fixed version

This recommendation table taking in account:

- Width of the MCCB palm (W)

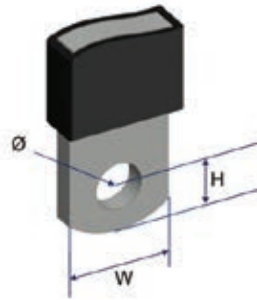

- Hole diameter of the MCCB palm (Ø)
- Hole position on the MCCB Palm (H)
- Rated current of the MCCB

This table does not take into account some specific installation environment, like ambient temperature, protection level of enclosure, altitude, frequency among other factors.

Some MCCB may need more important cross sections in function of the MCCB Power dissipation. In some case, increasing the IBS & IBSB Advanced cross section may be necessary to support MCCB heating dissipation. It is necessary to follow the instructions provided by the electrical device manufacturer.

CIRCUIT BREAKER COMPATIBILITY

Circuit Breaker Current Rating	125/160 A		250 A		300 A	350 A	400 A	500 A	630 A
	IBSB ADV 25x	IBSB ADV 25x	IBSB ADV 50x	IBSB ADV 50x	IBSB ADV 70x	IBSB ADV 100x	IBSB ADV 120x	IBSB ADV 185x	IBSB ADV 240x
Schneider Electric® Compact® (IEC)	NSA NG 125	NSX 100 NSX 160	NSX 250	NSX 250	NSX 400	NSX 400	NSX 400	NSX 630	NSX 630
Square D® PowerPact® (UL)	H-Frame	J-Frame	J-Frame	J-Frame	L-Frame	L-Frame	L-Frame	–	–
ABB® Tmax® (IEC)	T1 T2 XT1 XT2	–	T3 XT3 XT4	T3 XT3 XT4	T4	T4	T5	T5	T5
ABB® Tmax® (UL)	T1 T2 XT1 XT2	T3	T4 XT3 XT4	T4 XT3 XT4	T5	T5	T5	–	–
GE® Record Plus® (IEC/UL)	FD 160	FE 160	FE 250	FE 250	FG 400	FG 400	FG 400	FG 630	FG 630
Siemens® Sentron® (IEC/UL)	VL160X 3VL1 VL160 3VL2	–	VL250 3VL3	VL250 3VL3	VL400 3VL4	VL400 3VL4	VL400 3VL4	–	–
Moeller® xEnergy® (IEC)	NZM1		NZM2	NZM2	NZM3	NZM3	NZM3	NZM3	NZM3
Cutler Hammer® Series G (UL)	EG Frame	JG Frame	JG Frame	JG Frame	LG Frame	LG Frame	LG Frame	LG Frame	LG Frame
Legrand® (IEC)	DPX 160 DPX3 160	–	DPX 250 DPX3 250	DPX 250 DPX3 250	DPX 630	DPX 630	DPX 630	DPX 630	DPX 630
Hager® (IEC)	h3 160	–	h3 250	h3 250	h3 630	h3 630	–	–	–
Rockwell/Allen Bradley (UL)	G-Frame H-Frame	–	I-Frame J-Frame	I-Frame J-Frame	I-Frame J-Frame	–	K-Frame	K-Frame	–
Mitsubishi Electric (IEC)	–	NF125 NF160 DSN125 DSN160	NF250 DSN250	NF250 DSN250	–	NF400 DSN400	–	–	–
OEZ (IEC)	BC160N	–	BD250N BD250S	BD250N BD250S	BH630B BH630S	BH630B BH630S	BH630B BH630S	BH630B BH630S	BH630B BH630S

nVent ERIFLEX IBS & IBSB Advanced Connection on Power blocks

nVent ERIFLEX offers a wide selection of compact halogen-free & flame retardant power blocks, four pole distribution blocks and a complete range of assembly support products for easy fastening to DIN rails or steel sheet. The blocks offer easy assembly with visual inspection to allow for confirmation of connections to a wide range of conductors including IBS & IBSB Advanced. The high fill ratio ensures optimal electrical connectivity even in tight assemblies

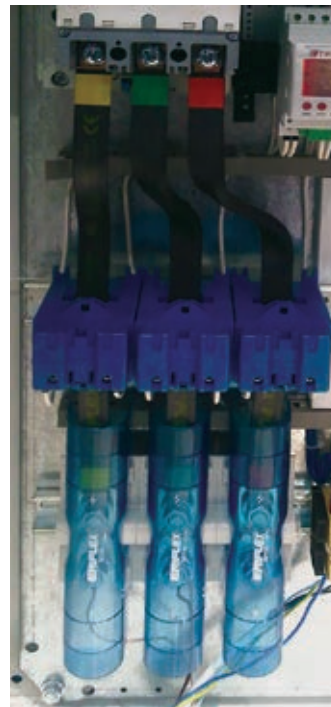

Application pictures: IBS & IBSB Advanced connected directly on ERIFLEX Power terminal and power blocks

Power Blocks (SB series)



- Directly connect IBS & IBSB Advanced on line side
- Compact power block with high short circuit current rating
- Tinned copper or aluminum block allows for copper or aluminum conductor connections
- Screw retaining cover is hinged and removable
- Design allows for visual inspection of conductor and confirmation of connection
- Gangable for building multi-pole power blocks
- Easily clips onto DIN rail or mounts to panel with screws
- Voltage detection and measurement connection
- 95% fill ratio
- Halogen-free
- RoHS compliant

nVent ERIFLEX IBS & IBSB Advanced Connection on Power blocks

Power Terminals (SBLL & SBLT Series)



- Tinned copper block allows for copper or aluminum conductor connections
- Accessible studs allow for easy connection of sections of IBS & IBSB Advanced or other conductors
- Design allows for visual inspection of conductor and confirmation of connection
- Adjustable transparent cover
- Gangable for building multi-pole power blocks
- Easily clips onto DIN rail or mounts to panel with screws
- SBLEC Power Terminals Fixing Accessory required for direct panel mount
- Halogen-free
- RoHS compliant

Single Pole Distribution Blocks (UD series)



- Directly connect IBS / IBSB Advanced on line side
- Tinned copper or tinned aluminum block allows for copper or aluminum conductor connections
- Screw retaining cover is hinged and removable
- Design allows for visual inspection of conductor and confirmation of connection
- Stackable for building multi-pole power blocks
- Easily clips onto DIN rail or mounts to panel with screws
- 95% fill ratio
- Halogen-free a part of the nVent ERIFLEX Advanced Technology range
- RoHS compliant.
- On some model IP 20 slider to ensure positioning IP 20 finger safe features with flat conductors

TDL Compact Four Pole Distribution Block, 400 A



- Connect IBS & IBSB Advanced, insulated braided conductor or cable with lug on line side
- Tinned copper bars allows for copper or aluminum cable
- Transparent protection covers
- Easy and safe connections
- Easily clips onto DIN rail or mounts to panel with screws
- Solid bars provide reliability
- Input separated from outputs
- Supports wiring from both sides
- Design allows for visual inspection of conductor and confirmation of connection
- Large end terminals
- High percentage of fill ratio
- Wiring with or without terminal
- Halogen-free
- RoHS compliant

Fixing and Securing nVent ERIFLEX IBS & IBSB Advanced

According to standards IEC 61439-1, insulated conductors must not rest up against bare live parts or against metallic parts. As they are Class II certified, IBS & IBSB Advanced can be touch and fix directly to any metallic parts (no clearance distance needed).

Different minimum creepage distance need to be followed between metallic part and stripped IBS & IBSB Advanced part (e).

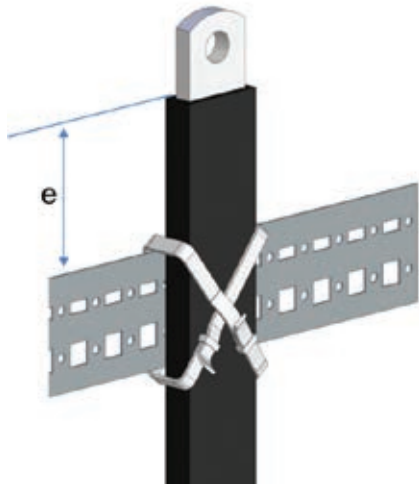

Thanks to the high quality of the IBS & IBSB Advanced insulation (Class II/reinforced insulation), mutual contact or contact with conductive parts is allowed and there should not be risk of mechanical damage. Consequently, it is not necessary to fix IBS & IBSB Advanced in absence of sharp edges or proximity with electrical device.

In the case of proximity with sharp edges, IBS & IBSB Advanced is an insulated conductor, unlike a bare solid bar, so there is no calculation required for support according to a short-circuit level. Nevertheless, IBS & IBSB Advanced needs to be maintained to avoid any damage and ensure the protection of the surrounding material in case of a short-circuit current inside the switchboard.

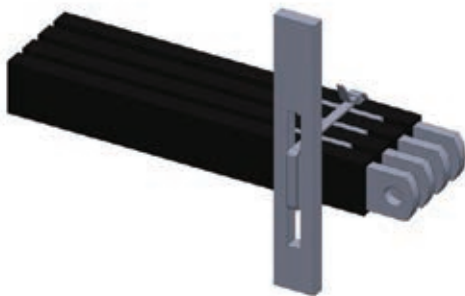

The protection of the sharp edges can be done by rebate seals, rectangular glands, plastic screens, etc.

It is recommended that fixed spacers or ties be secured to the framework every 630 mm, for any level of potential short-circuit.

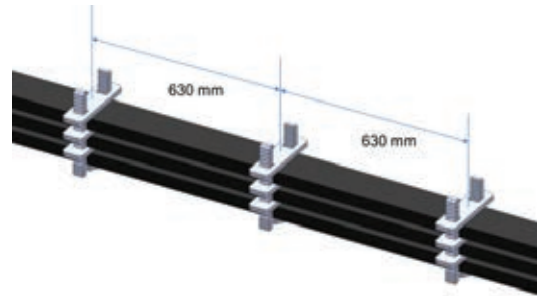

Installers should use nVent ERIFLEX spacers (FS, RFS, UFS kit) to improve the aesthetics global feature.

The last spacer should be located as close as possible to the device connection.

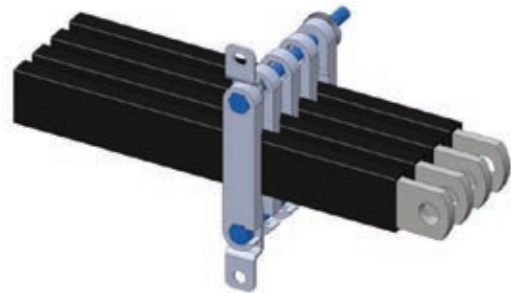

IN CASE OF PLASTIC TIE USED, WE RECOMMEND:

- Tie type 4.5mm minimum width.
- Do not tight tie with tool, but gently by hand in order to not compromise insulation integrity.



Fixing and Securing nVent ERIFLEX IBS & IBSB Advanced

- Do not put tie collar junction on IBS & IBSB Advanced corners, but rather on the plane surface
- The weight of supported IBS & IBSB Advanced should be below tie mechanical resistance.

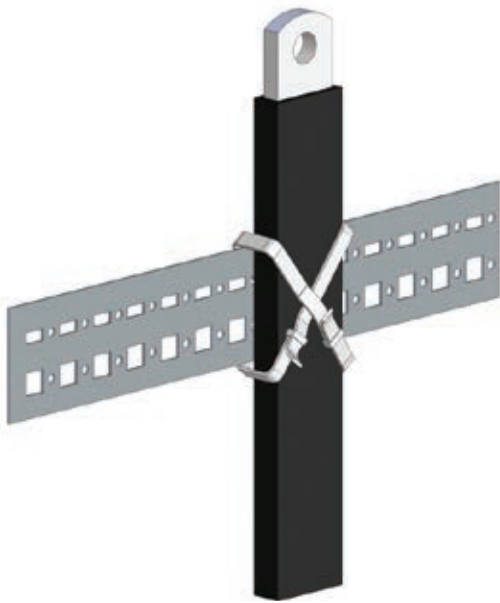

- If the tie need to be removed after IBS & IBSB Advanced have been submitted to the temperature close to the maximum admissible of the insulation, a visual inspection needs to be performed to check insulation integrity.
- The last tie should be located as close as possible to the device connection.

In cases where several IBS & IBSB Advanced products are installed in parallel, a minimum distance of a few millimeters is recommended for air cooling. To ensure that conductors are properly ventilated, a space should be left between the flexible bars, at each tie or spacer. Multiple IBS & IBSB Advanced per phase shall be spaced with a min adjacent distance of 4mm for ventilation.



Note: The cooling is better for a rectangular bar standing on its edge.

NVENT ERIFLEX ACCESSORIES AND SOLUTIONS FOR FIXING/SECURING IBS & IBSB ADVANCED

nVent ERIFLEX offers a wide selection of accessories and solutions to fix and secure IBS & IBSB Advanced on edge position or flat position. Those clamps allow:

- Fixing/Securing without damaging the insulation
- Fixing/Securing with correct spacing for optimum cooling
- Fixing/Securing multiple IBS & IBSB Advanced in parallel



Fixing and Securing nVent ERIFLEX IBS & IBSB Advanced

UFS Support Kit



- Kit includes one rail and 24 retaining blocks
- Create up to three 650 mm (25.6") supports capable of holding four IBS & IBSB Advanced
- Retaining blocks are halogen free
- RoHS compliant
- Conductor Thickness : 2 – 10 mm
- Conductor Width : 15.5 – 120 mm
- Recommended distance between supports is 630 mm for IBS & IBSB Advanced

FS Spacer Clamp



- Provides support for IBS & IBSB Advanced without damaging the insulation
- Ensures correct spacing for optimum cooling
- Supports up to four conductors in parallel
- Easy to install
- Spacers are halogen free
- RoHS compliant
- Conductor Width : 40 – 100 mm
- Recommended distance between supports is 630 mm for IBS & IBSB Advanced

FS Spacer Clamp, Snap Close



- Provides support for IBS & IBSB Advanced without damaging the insulation
- Ensures correct spacing for optimum cooling
- Supports up to four conductors in parallel
- Easy to install
- Halogen-free
- Conductor Width : 15,5 – 32 mm
- RoHS compliant
- Recommended distance between supports is 6360 mm for IBS & IBSB Advanced

Fixing and Securing nVent ERIFLEX IBS & IBSB Advanced

RFS Reinforced Support



- Supports up to eight conductors in parallel
- Ensures correct spacing for optimum cooling
- Easy to install
- Spacers are halogen-free
- RoHS compliant
- Conductor Width : 40 – 100 mm
- Recommended distance between supports is 630 mm for IBS & IBSB Advanced

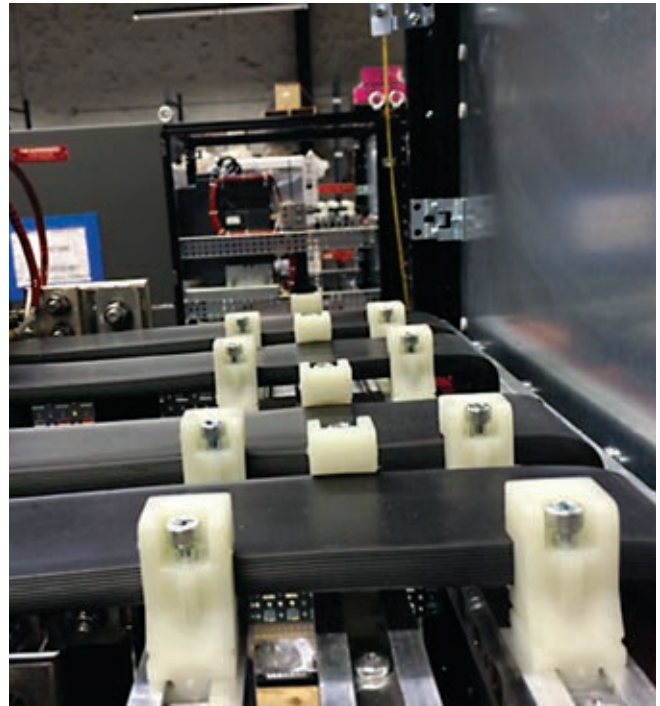
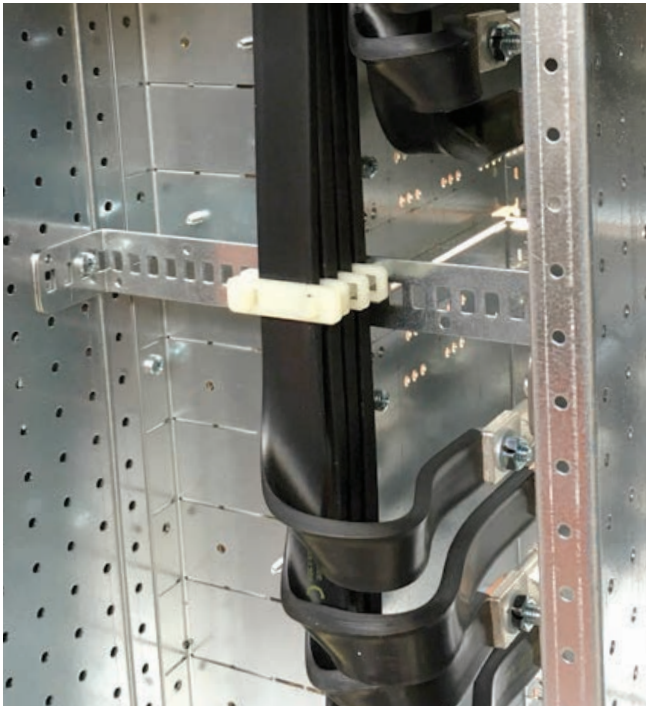

Fixing and Securing nVent ERIFLEX IBS & IBSB Advanced



NVENT ERIFLEX END COVERS

- End cover for IBS & IBSB Advanced
- Allows for visual inspection of connection
- Easy fitting after fixing
- RoHS compliant
- Material: Polycarbonate
- Flammability rating: UL® 94V-0
- Halogen-free



Product Marking/Identification

Product Brand (ERIFLEX)

Product Name

(IBSB) = Ready-to-Use Power conductor

Advanced Technology

(Low Smoke, Halogen-Free, Flame Retardant insulation)

Part Number / ordering code (six digit code)

Conductor Cross section (mm²)

Length (mm)

Metric Hole size 1 (10 = M10)

Metric Hole size 2

UL Certification – Recognized (certification agency is UL)

C = Canada

US = USA

AVLV2/8 = Appliance Wiring Material – Component

QEUY2/8 = Panelboard and Switchboard Accessories – Component

CSA Certification (certification agency is CSA)

CSA Master File number (160371)

AWM Class = I (internal wiring of equipment)

AWM Group = A/B (no restriction on mechanical abuse)

Temperature Rating = 115°C (maximum continuous operating temperature)

Voltage = 1000V AC (voltage rating)

Flame classification = FT1 (vertical flame test)

European Conformity – according to IEC 61439-1

LS = Low Smoke

HF = Halogen Free

FR = Flame Retardant

Quality / traceability code



Product Modification

GENERAL MODIFICATION GUIDE

nVent ERIFLEX IBS & IBSB Advanced Product modification is easy and can be accomplished with standard tools. When fabricating small quantities, ordinary hand tools are adequate. When fabricating large quantities, dedicated production tooling is more cost effective.

SAFETY

Observe common safety precautions when working on product modifications with IBS & IBSB Advanced. Wear safety glasses and gloves when around machinery and/or working material.

- Do not damage the insulation with things such as metal chips, heat, sharp tools.
- Plastic mallet can be used to flatten folding shape. Do not use metallic hammer.
- No contact to solvents or acids.
- Do not expose to dirt, water and humidity. This causes copper oxidation and endangers operating safety

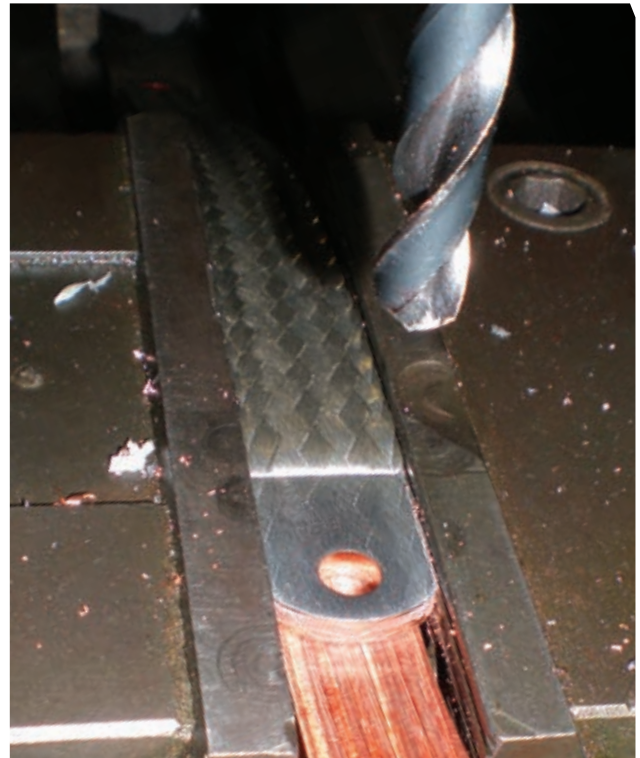

Product Modification

HOLE SIZE MODIFICATION

nVent ERIFLEX IBS & IBSB Advanced is ready-to-use and provided pre-punched.

The hole size has been designed for connections to all molded case circuit breakers, including the most compact breakers on the market. However, it is possible to enlarge hole size using drilling systems. This can be done on the axis of the existing hole only when drilled.

The below table provide some guidance regarding maximum hole size modification.

- Hole modification using drilling system only
- Never use punch
- Drill on the axe of the existing hole
- Use wood back plate to avoid copper burr
- Chamfer hole to remove copper burr and keep good contact surface
- Made sure there is no burr and chips between insulation and copper braid

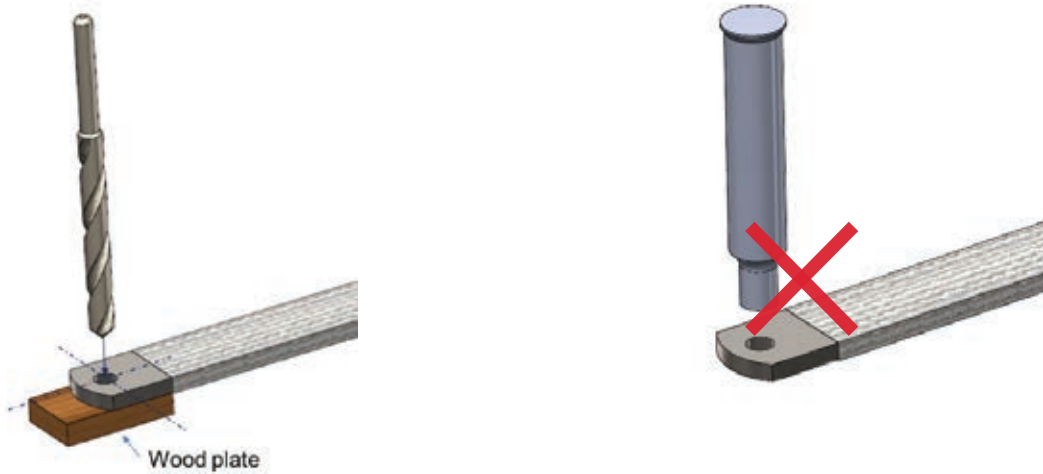

Insulated Braided conductor type	Cross Section (mm ²)	Maximum Hole size modification (mm)	Original Hole Size		Maximum Hole size modification (mm)		
			HS1 (mm)	HS2 (mm)			
IBSBADV25	25	NO	6.5		6.5	NO	
IBSADV25	25	12.5	8.5		10.5	12.5	
IBSBADV50	50		8.5		10.5		
IBSADV50	50		10.5		10.5		
IBSBADV70	70		8.5		10.5		
IBSBADV100	100		8.5		10.5		
IBSBADV120	120		10.5		10.5		
IBSBADV185	185		10.5		12.5		NO
IBSBADV240	240		10.5		12.5		NO

Product Modification

It is also possible to enlarge hole size using milling tool. In this case, the hole axe can be decentralized.



By default, the edge-of-hole to edge-of-part minimum distance (A and B) is indicated on the below table.

Insulated Braided conductor type	Cross Section (mm ²)	A (mm)	B (mm)
IBSBADV25	25	5	3
IBSADV25	25	5	3
IBSBADV50	50	5	3
IBSADV50	50	5	3
IBSBADV70	70	5	4
IBSBADV100	100	5	4
IBSBADV120	120	5	8
IBSBADV185	185	7	8
IBSBADV240	240	7	8

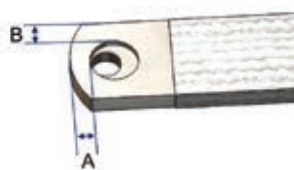

Drilling and Milling diameter depends on the diameter of the bolts and nuts used.

Bolt Diameter (Metric)	Max. Drilling diameter (mm)	Bolt Diameter (Imperial)	Max. Drilling diameter (Inches)
M6	7	1/4" – 20	5/16"
M8	10	5/16" – 18	3/8"
M10	12	3/8" – 16	7/16"
M12	14	7/16" – 14	1/2"
		1/2" – 13	9/16"

RECOMMENDED TOOL

nVent ERIFLEX Flexidril Drill Guide.

- Guide for drilling holes into IBS & IBSB Advanced and other flat conductors
- Includes dies for multiple diameters
- Metric and imperial version
- RoHS compliant



BENDING

A Bend of the nVent ERIFLEX IBS & IBSB Advanced palm can be realized under conditions shown on the side illustration. Bend angle can be realized from 0° up to 100°.

The bend can be realized with a 5 mm radius and from 5 mm distance from the solid palm.

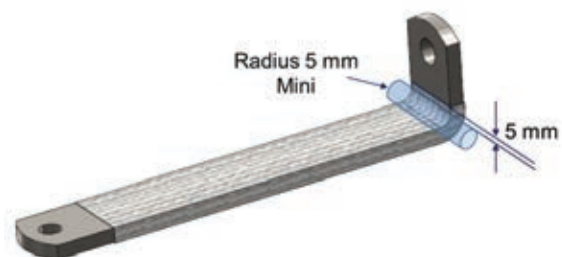

nVent ERIFLEX IBS & IBSB Advanced Custom Solutions (Made to Order)

nVent ERIFLEX can provide modified IBS & IBSB Advanced configurations to your drawing specifications. ERIFLEX IBS & IBSB Advanced can be design with specific length and hole size to address your most challenging panelboard designs and production scheduling requirements.

Let the nVent ERIFLEX Team solve your low voltage connection challenges!



Dedicated nVent ERIFLEX Software Available

nVent ERIFLEX has designed interactive software that allows drawing your technical panel layout with all components and relevant information on them.

The software is developed according to the new IEC 61439-1 standard. Inside, you will discover updated pricing, products information and project calculator.

Whether you're interested in making a complete low-voltage busbar system, a distribution kit, or if you need to determine a flexible connection with IBS & IBSB Advanced, you can trust ERIFLEX software to help simplify the process.

In fact, the software will provide you with technical and commercial datasheets dedicated to your project.

For more information or to request your personal login information, contact your local Pentair representative or visit <https://eriflex-configurator.nvent.com/eriflex/>



A COMPLETE SOLUTION FOR:

- Optimal design
- Cost effective
- Standard compliance
- Quality environment

Applications Pictures

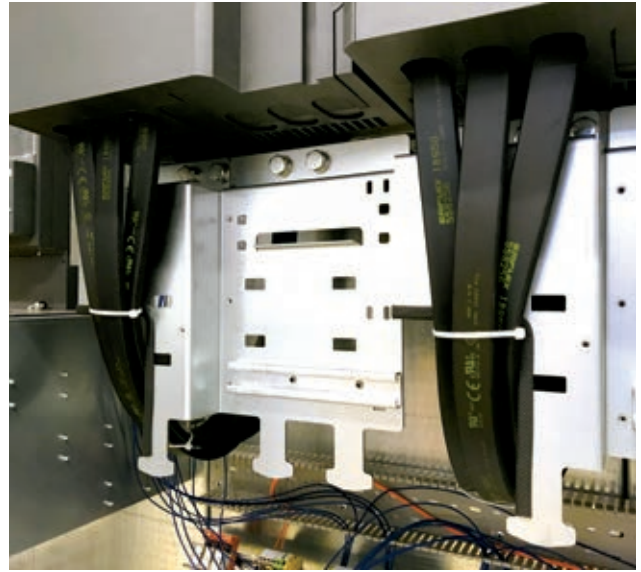

Applications Pictures

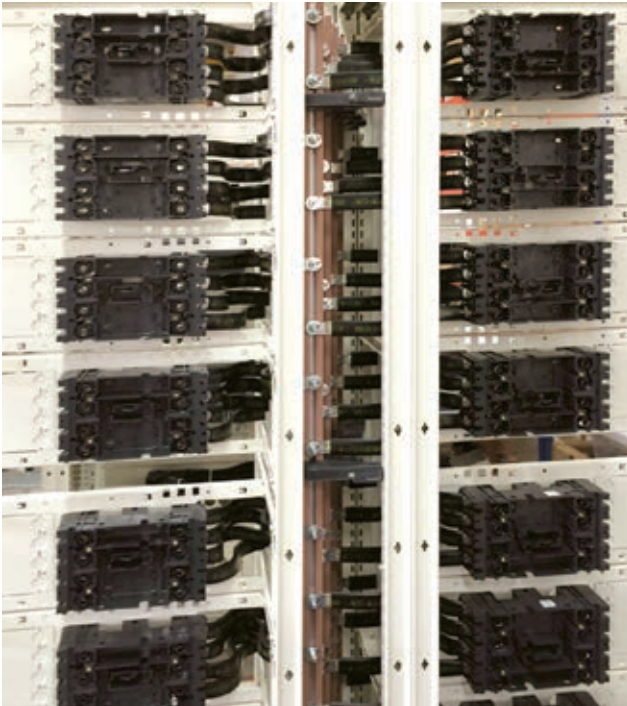

Applications Pictures



Other nVent ERIFLEX Literature

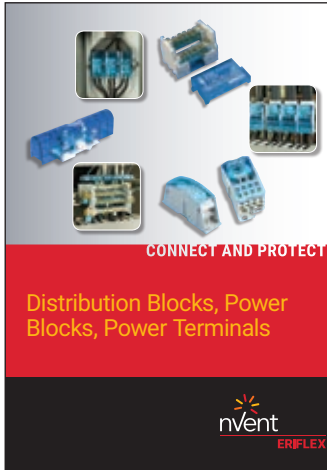

**DISTRIBUTION BLOCKS,
POWER BLOCKS AND
DISTRIBUTION TERMINAL**

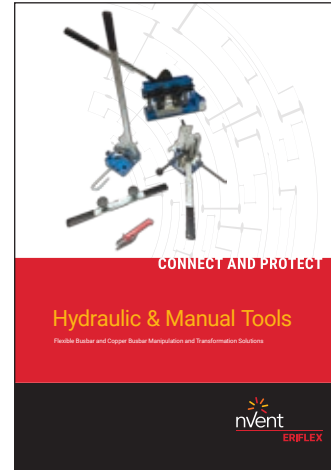

**HYDRAULIC & MANUAL
TOOLS**

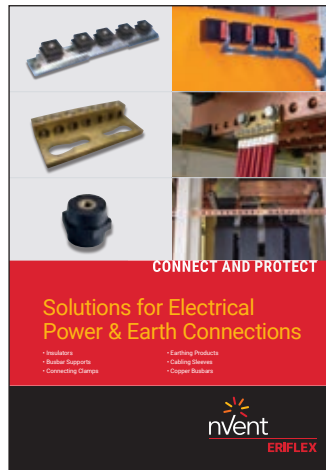

**SOLUTIONS FOR ELECTRICAL
POWER & EARTH
CONNECTIONS**



**THE FLEXIBLE CONDUCTORS
CATALOG HIGHLIGHTS A RANGE
OF HIGH-QUALITY PRODUCTS
TO OPTIMIZE THE DESIGN OF
LOW-VOLTAGE POWER AND
GROUND CONNECTIONS FOR A
VARIETY OF APPLICATIONS**

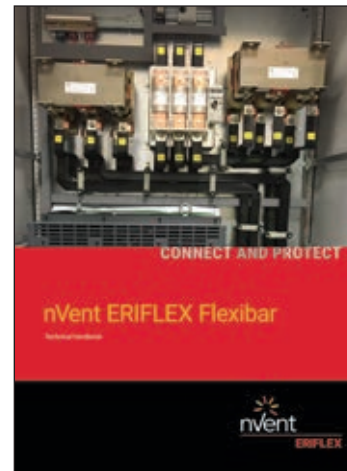

**NVENT ERIFLEX FLEXIBAR
TECHNICAL HANDBOOK**

Our powerful portfolio of brands:

CADDY ERICO HOFFMAN RAYCHEM SCHROFF TRACER



nVent.com/ERIFLEX