

Operator manual: ADELSYSTEM reserves the right to change the contents of this document without prior notice.

1 QUICK START

Quick start for CBI60, please refer to Section: 7; 10.3.1; 13

2 “ALL IN ONE” DC UPS SERIES

Thank you for having chosen one of our products for your work.

We are certain that it will give the utmost satisfaction and be a notable help on the job.

3 GENERAL DESCRIPTION

Thanks to “All In One” CBI series of DC-UPS, it will be possible to optimize the power management of your system with one single, extremely compact and cost-effective device, connected directly to the mains. The available power is automatically distributed between load and battery giving priority to the load. Battery can supply the load even with mains so the output power to the load can be twice the nominal power if it is required (Power Boost). When mains failure occurs, the load continues to be supplied by the battery in backup mode. It is also possible to switch on the device with no mains directly from battery. The “Battery Care” algorithm performs rapid and automatic charging, battery charge optimization during time, flat batteries recovery and real time diagnosis during installation and operation. Temperature compensation is possible by connecting the temperature sensor probe. The real time auto-diagnostic system monitors battery faults such as sulphated battery, shorted cells, accidental reverse polarity connection or disconnection of the battery. Each fault is signaled by a blink code of Diagnosis Led or via Modbus (only in some models) in order to be easily detected and removed during the installation and after sales. The continuous monitoring of battery efficiency reduces risk of battery damage and allows a safe operation in permanent connection. Predefined curves can be selected by jumpers or DIP switch to optimize the charge of different battery types: Open Lead Acid, AGM and Gel Lead Acid; Ni-Cd are rechargeable using the same device. Charging curves can be customized via Modbus (only in some models). Output dry contacts are used to signal both backup and fault conditions. A rugged casing with bracket for DIN rail mounting provides IP20 protection degree.



4 MAIN CHARACTERISTICS

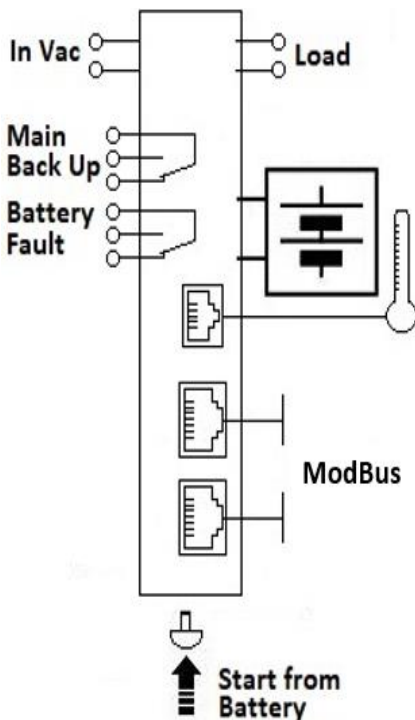

- Universal input voltage: single-phase 115–230-277 Vac
- Load output: 24 Vdc 3,5,10,20A; 12 Vdc 3,6,10,15,35A 48 Vdc 5,10A
- Battery output: 24 Vdc 3,5,10,20A; 12 Vdc 3,6,10,15,35A; 48 Vdc 5,10A
- “All In One” solution: power supply + battery charger + backup module in one single device connected directly to the mains
- Suited for different battery types: Open Lead Acid, Sealed Lead Acid, AGM and Gel Lead Acid; Ni-Cd and Li-ion are available as options. Four stage charging curve for Lead Acid batteries: 5-stage IUoU (Recovery, Bulk, Absorption, Float, Refresh Battery) plus Recovery stage for deeply discharged batteries
- Automatic diagnosis of battery status and battery Life Test function (Battery Care)
- Switching technology with high efficiency
- Protected against short circuit, overload and inverted polarity
- Output dry contact for signaling Low Battery or Battery Replacement and Fault system. CBI60 have only Mosfet Connections.
- Output dry contact for signaling Mains or Backup
- IP20 protection degree
- Space saving on DIN rail

5 SAFETY AND WARNING NOTES



- WARNING – Explosion Hazard. Do not disconnect Equipment unless power has been switched off or the area is known to be non-hazardous.
- WARNING – Explosion Hazard. Substitution of components may impair suitability for class I, Division 2.

- **WARNING** – Switch off the system before connecting the module. Never work on the machine when it is live. The device must be installed in according with UL508 or UL60950. The device must have a suitable isolating facility outside the power supply unit, via which can be switched to idle. Danger of fatal Injury!
- **WARNING** - Residual voltage. Wait for 10 seconds before operating on the device CBI2420A and CBI485A.

6 CONNECTION

6.1 CONNECTION TERMINAL AND WIRING

The following cable cross-sections may be used:

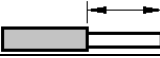
	Solid (mm ²)	Stranded (mm ²)	AWG	Torque (Nm)	Stripping Length 	All In One (Size)
In:	0.2 – 2.5	0.2 – 2.5	24 – 14	0.5 – 0.6 Nm	7 mm	Size 1 and 2
	4.0	6.0	30 – 10	0.8 – 1.0 Nm	7 mm	Size 3 and 4
Out:	0.2 – 2.5	0.2 – 2.5	24 – 14	0.5 – 0.6 Nm	7 mm	Size 1 and 2
	4.0	6.0	30 – 10	0.8 – 1.0 Nm	7 mm	Size 3 and 4
Signal:	0.2 – 2.5	0.2 – 2.5	24 – 14	0.5 – 0.6 Nm	7 mm	All types

Connection by the screw, type 2.5 mm² or 4.0 mm² terminal blocks. Wiring terminal shall be marked to indicate the proper connection for the power supply. Use copper cables only, for supply connections, use wires suitable for at least 75°C.

6.2 INPUT LINE SYSTEM

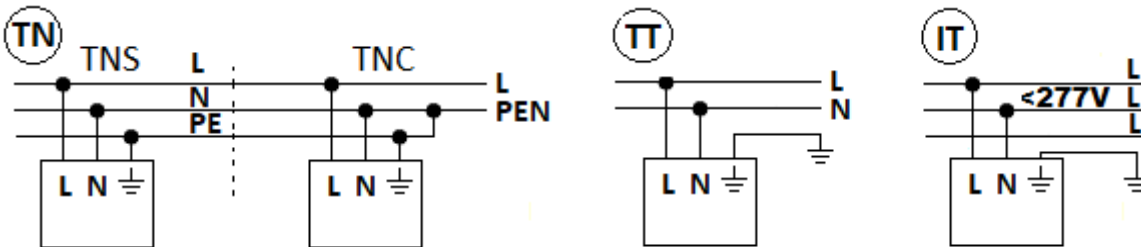

6.3 OUTPUT POWER CONNECTIONS: LOAD AND BATTERY

6.3.1 Normal connection

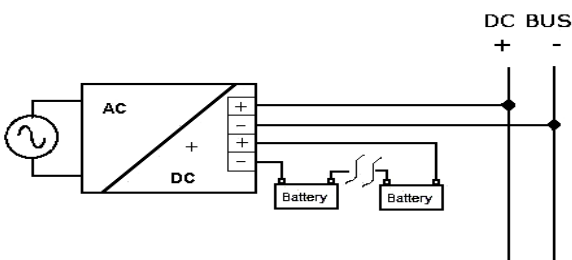

Typical application for All In One device, one output for Load “DC Bus”, one Input / Output for connection to the battery.

- N°1 battery (12 Vdc) for CBI 12xx;
- N°2 battery (12 Vdc) connected in Series for CBI 24xx;
- N°4 battery (12 Vdc) connected in Series for CBI 48xx;

6.3.2 Parallel connection “Redundancy”

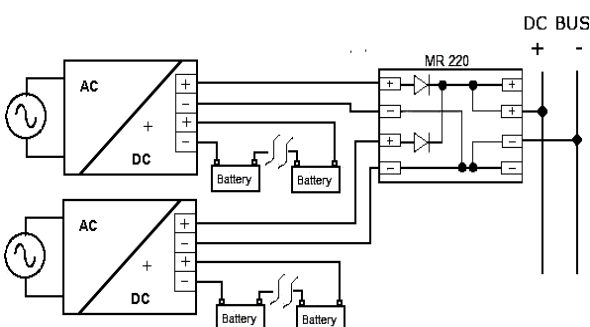

Parallel connection “Redundancy”

Power supplies can be paralleled in case of redundancy concept, to obtain a higher system reliability. Redundant systems may support N+1 redundancy to safeguard against single-point failures, or to enable hot-swapping of a failed supply without system impact. The simplest way is to put two CBI in parallel. In case one power supply unit fails, the other one is automatically able to support the load current without any interruption. To separate completely a hypothetical device failure, it is necessary add the decoupling diodes which are

included in the Redundancy Module MR220. Recommendations for building redundant power systems: a) Use separate input fuses for each CBI. b) Monitor the individual CBI units by three LED. Each unit has two relays: Mains or backup and Low Battery or Battery Replacement (faulty situation). This feature reports a faulty unit; see Relay Contact Rating for any technical detail. c) When possible, connect each power supply to different phases or circuits

6.3.3 Parallel connection “Redundancy One Battery Source”

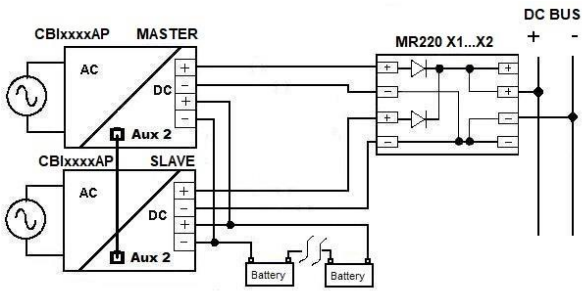

Parallel connection “Redundancy” is also possible with the CBI 600W: CBI1235AP, CBI2420AP, CBI4810AP

Power supplies can be paralleled in case of redundancy concept only for the power supply function but not for the battery energy. Redundant systems may support N+1 redundancy to safeguard against single-point failures, or to enable hot-swapping of a failed supply without system impact. The simplest way is to put two CBI in parallel. In case one power supply unit fails, the other one is

automatically able to support the load current without any interruption. To separate completely a hypothetical device failure, it is necessary add the decoupling diodes which are included in the Redundancy Module MR220. Recommendations for building redundant power systems: a) Use separate input fuses for each CBI. b) Monitor the individual CBI units by three LED. Each unit has two relays: Mains or backup and Low Battery or Battery Replacement (faulty situation). This feature reports a faulty unit; see Relay Contact Rating for any technical detail. c) When possible, connect each power supply to different phases or circuits. The redundancy it is not reliable in Back Up situations because the battery connected are only one branch. It is necessary to use a standard UTP or order Cable code: ERJ.CBI.004 for RJ45, and connect to Aux2 of each device. The communication protocol is based on CAN2.0A standard.

6.3.4 Parallel connection “Double Power”

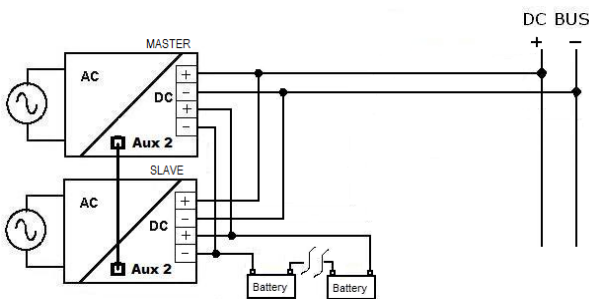

Power supply can be paralleled to increase the output power, devices can be paralleled for 1+1=2 to obtain the double power of a single unit. Only SIZE 3 devices in the specific “P” version (i.e.CBI1235AP, CBI2420AP, CBI4810AP) can be connecter in parallel to attain the sum of the current at the same output voltage. It is necessary to use a standard UTP or order Cable code: ERJ.CBI.004 for RJ45, and connect to Aux2 of each device. The communication protocol is based on CAN2.0A standard.

In this way the system has only One output for the Load

and One output for the battery.

- Use separate input fuses for each CBI.
- Make sure that the two CBI have the same settings: Battery type, Charging level current, Time buffering, Life test...
- Automatic configuration, Master-Slave. The devices decide themselves their Master and Slave assignment randomly. The assignment is done at every power on, or after the connection of the RJ45 cable. Master device provide all the visual signals, the Slave device maintain the diagnosis LED always ON.
- Use the alarm contacts of both the two devices and deliver them as needed.
- For Start Battery there are two way, without mains voltage:
 - push start button on both units
 - connect Cable "RTCONN" on position 5, to connect pushbutton on a front panel.

6.3.5 Series connection:

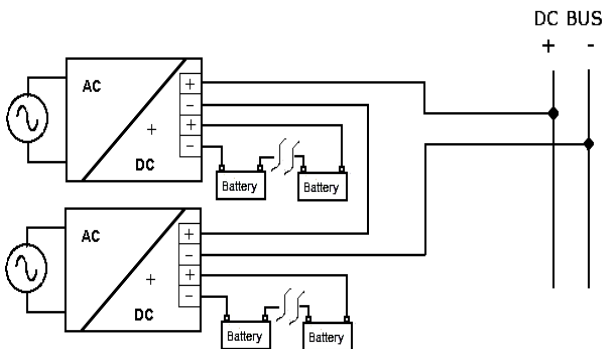

It is possible to connect as many units in series as needed, provided the sum of the output voltage does not exceed 150Vdc. a) Voltages with a potential above 60Vdc are not SELV anymore and can be dangerous. Such voltages must be installed with a protection against touching. b) For serial operation use power supplies of the same type. c) Earthing of the output is required when the sum of the output voltage is above 60Vdc. d) Keep an installation clearance of 10 mm (left/right) between two power supplies and avoid installing the power supplies on top of each other. Note: Avoid return voltage (e.g.

from a decelerating motor or battery) which is applied to the output terminals.

6.4 OUTPUT LOAD (MAINS INPUT ON)

The output Load in normal mode, Mains Input Vac Voltage present, follows the charging battery dc output voltage. The minimum and maximum range stabilized are the following:

CBI 12xx:11 – 14,4 Vdc; 15,5 Vdc for NiCd (Without battery connected out. Voltage fixed at 12Vdc)

CBI 24xx:22 – 28.8 Vdc; 30 Vdc for NiCd (Without battery connected out. Voltage fixed at 24Vdc)

CBI 48xx:44 – 57.6 Vdc; 62 Vdc for NiCd (Without battery connected out. Voltage fixed at 48Vdc)
 Thanks to the All In One units, it will be possible to manage the power. The available power, is automatically allocated between load and battery: supplying power to the load is the first priority of the unit; thus it is not necessary to double the power and also the power available for the battery will go to the load if the load requires it.

In “Power Boost Mode” the maximum current on the load output is the 2 times the rated current $2 \times I_n$ ($I_{load} = I_n + I_{batt}$) in continuous operation and 3 times the rated current $3 \times I_n$ ($I_{load} = 2I_n + I_{batt}$) for 4 seconds; after this power the device is electrically protected against overload and short circuit.

- In “Power Boost Mode”, if the the battery provide current to the load for longer than 4 minutes, the device outputs a message (8 Blink) to warn that the battery is discharging.
- If the Mains Input Voltage fall below a Threshold level (50% of the Typ. Vac input) the battery is immediately connected to the Output Load, without any interruption.
- Voltage dips: In this situation the voltage in the output load is the same of the battery.
- **To Avoid deep battery discharge**, the battery will supply the load until battery voltage reaches the minimum V/cell. Below this level the device automatically switches off to prevent Deep discharge and battery damage.

6.5 OUTPUT LOAD: TIME BUFFERING MODE (MAINS INPUT OFF)

Some example of buffering time depending on LOAD Output in function to the Ah of the battery.

Buffering Time	BATT1.2 Ah	BATT 3 Ah	BATT7.2 Ah	BATT12 Ah	BATT100 Ah
Load 1.5 A	20 min	60 min	200 min	400 min	/
Load 3 A	8 min	30 min	120 min	240 min	/
Load 5 A	3 min	15 min	55 min	100 min	/
Load 7.5 A	2 min	10 min	30 min	60 min	/
Load 10 A	No	7 min	20 min	45 min	20 h
Load 12 A	No	3 min	12 min	30 min	600 min
Load 15 A	No	No	9 min	20 min	400 min
Load 20 A	No	No	7 min	13 min	240 min

7 LAY-OUT AND CONNECTIONS

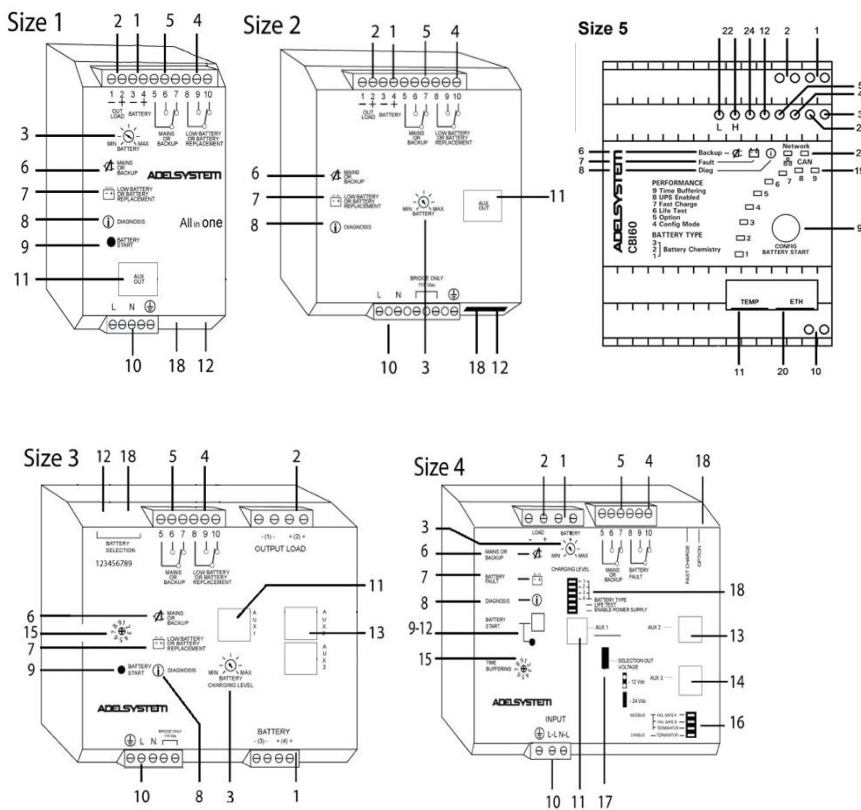

1	Battery
2	Load
3	Charging Current Limiter
4	Fault System
5	Mains-BackUp
6	Mains-BackUp LED
7	Fault LED
8	Diagnosis LED
9	Config/Start From Battery
10	Input Vac
11	Aux 1 (RJTemp)
12	Start From Battery (Connector)
13	Aux 2
14	Aux 3
15	Buffering Time
16	Bus Termination
17	12/24 Output
18	Battery Config.
19	Battery Config, All device Functions
20	Aux 4 “Ethernet”
21	Network Commun. LED
22	ADELBus (CAN)
23	Rectifier Alarm
24	PE (Aux 4 screen)

8 INPUT AND OUTPUT LOAD AND BATTERY CONNECTION

8.1.1 Input AC Port L – N:

No.10



Single phase Switching Power Supplies L, N, PE ⊕.



Size 2 and Size 3 BRIDGE ONLY for input 115 Vac, and connect L, N, PE ⊕.

8.1.2 Battery Connection Port:

No.1: Connect the battery between: terminal 3 (–) and 4 (+)

One battery (12 Vdc) for CBI12xx;

Two battery (12 Vdc) connected in Series for CBI24xx;

Four battery (12 Vdc) connected in Series for CBI48xx;

8.1.3 Output Load:

No.2: Connect this Output to the load, terminal 1 (–) and 2 (+).

8.2 SELECT OUTPUT VOLTAGE (ONLY SIZE4 CBI280)

No.17: Caution: Switch off the system before setting the Jumper. The Jumper is detected at the device power-up only.

Output Voltage Selection	- 24 Vdc	Jumper 24V Output Voltage
Output Voltage Selection	- 12 Vdc	No Jumper 12V Output Voltage

9 DRIVE AND MONITORING

9.1 FAULT - STATUS CONDITIONS

9.2 ISOLATED RELAY (SIZE:1,2,3,4):

9.2.1 STATUS: Mains or Backup: Input Mains On/Off.

- No.5 Relay Contacts: 5, 6, 7
- No.6: Led

9.2.2 FAULT: Low Battery, Battery Replacement, Faulty Battery or Faulty System

- No.4 Relay Contacts: 8,9,10
- No.8: Led DIAGNOSIS: Diagnosis of the system through “blinking code” light signal

9.2.3 Back Up and Fault: Relay and LED Conditions

Relay:		Port N°5 - Led N°6 Mains/Back-Up		Port N°4 - Led N°7 Fault Battery	
		5-6 Closed OK	5-7 Closed	8-9 Closed OK	8-10 Closed
Mains Input Vac	ON	■ - led off		■ - led off	
	OFF		■ - led On (1)	■ - led off	
Battery SOC less than 30%	YES		■ - led On		■ - led On (2)
	NO		■ - led On	■ - led off	
Battery or system Fault?	YES	■ - led off			■ - led On
	NO	■ - led off		■ - led off	

Note:

(1) Contact relay Mains/Back switch at least 5 seconds after disconnection of Power.

(2) See Diagnosis Led

9.2.4 Relay Contact Rating:

Max.DC1: 30 Vdc 1 A; AC1: 60 Vac 1A: Resistive load (EN 60947-4-1).Min.1mA at 5 Vdc: Min. permissive load

9.3 NOT ISOLATED OUTPUT (SIZE 5):

9.3.1 STATUS: Mains or Backup “Input Mains On/Off“.

- No.5 Output ON: open drain referred to Load negative terminal; requires an external DC power source (max 48Vdc) – drain current: 20 mA Nom ; 40 mA Max for 3 sec
- No.6: Led ON

9.3.2 FAULT 1: Low Battery, Battery Replacement, Faulty Battery or Faulty System

- No.4 Output ON: open drain referred to Load negative terminal; requires an external DC power source (max 48Vdc) –drain current: 20 mA Nom ; 40 mA Max for 3 sec
- No.8: Led DIAGNOSIS: Diagnosis of the system through “blinking code” light signal

















9.3.3 FAULT 2: Rectifier Alarm

- No.4 Output ON: open drain referred to Load negative terminal; requires an external DC power source (max 48Vdc) – drain current: 20 mA Nom ; 40 mA Max for 3 sec
- No.8: Led DIAGNOSIS: Diagnosis of the system through “blinking code” light signal

9.4 CHARGING MODE STATUS

	Status	Diagnosis (No.8)	Fault Battery (No.7)
Charging Type	Float	1 Blink/2 sec	OFF
	Absorption	1 Blink/sec	OFF
	Bulk	2 Blink/sec	OFF
	Recovery	5 Blink/sec	OFF

9.5 FAULTY BATTERY / FAULTY SYSTEM

System Auto Diagnosis	Reverse polarity or high battery Voltage (over 32.5Vdc for CBI 24xxA)	1 Blink/pause 	ON
	Battery not connected	2 Blink/pause 	ON
	Battery element in Short Circuit	3 Blink/pause 	ON
	Overload or short circuit on the load	4 Blink/pause 	ON
	Bad battery; Internal impedance Bad or Bad battery wire connection	5 Blink/pause 	ON
	Life test not possible	6 Blink/pause 	ON
	Rectifier Alarm	7 Blink/pause 	ON
	Boost condition; battery discharge after 4 min. of overload.	8 Blink/pause 	ON
	Internal fault	9 Blink/pause 	ON
	Low battery (under 18.5Vdc for CBI 24xxA) Only if started from battery, no Mains input, from Jumper N°5 or Push Bottom	10 Blink/pause 	ON
	Master-Slave connection lost between the master and slave on parallel configuration, (AP device only 500W)	11 Blink/pause 	ON
	Mains detector failure	12 Blink/pause 	ON
	Bad battery wire connection; Parallel mode on Slave Device (AP device only 500W)	13 Blink/pause 	ON
	Device over-temperature Alarm	14 Blink/pause 	ON
	Boost condition; battery discharge after 4 min. of overload; Parallel mode on Slave Device (AP device only 500W)	15 Blink/pause 	ON
	Calibration error	16 Blink/pause 	ON

9.6 START FROM BATTERY ONLY, NO INPUT MAINS VAC



No. 9: Push-button, for 3 sec., in the front panel to switch ON the system without the “Mains input Vac” but only the battery connected. (Not present in CBI 2410XX and CBI 485XX)

No.12 /Jumper n.5) has the same function of remote start from battery, via RTCONN cable connected in the Push-button mounted on front Panel of the external system. Standard function for all products, Size 2 only with code CBI2410A/S and CBI485A/S. Do not leave jumper in this position, otherwise the system will discharge completely the battery. Only push button.

9.7 BUFFERING TIME SETTING

No.15: On Size 3 and Size 4 models it is possible to set a buffering time. The desired value can be selected on the rotary switch 15. Buffering time is initiated when the mains is switched OFF. The LOAD output will be ON for the selected time.

Switch position	0	1	2	3	4	5	6	7	8	9
Buffering Time (min.)	∞	0.5	2	5	10	15	20	30	45	60

If the switch is in position 0, the LOAD output will be in ON state until the battery is completely discharged. In any case, to prevent damage the unit disconnects the batteries when a minimum voltage level is reached. The LOAD output will be in ON state until the battery is completely discharged.

For Size 1 and 2 units it is possible to request factory customized versions with specific buffering time setting, choosing the extension CBIxxxxASDx.

For Size 5 units please refer to section 9.

10 BATTERY CARE

The Battery Care philosophy is based on algorithms that implement rapid and automatic charging, battery charge optimization during time, flat batteries recovery and real time diagnostic during installation and operation. Elements in short circuit, accidental reverse polarity connection, disconnection of the battery, can easily be detected and removed by help of Blink Code of Diagnosis Led, during the installation and after sale. Each device is suited for all battery types, it is possible setting predefined curves for Open Lead Acid, Sealed Lead Acid, Gel, Ni-Cd, Li-Ion. They guarantee battery reliability in time by continuously testing the internal impedance status, avoiding any possible risk of damage and granting a permanent, reliable and safe connection of the battery to the power supply. The system is able, through a battery stimulation circuit with algorithms of evaluation of the detected parameter, to recognize sulphated batteries or batteries with a short-circuited element. Battery Test: Automatic. Every 60 sec. battery connection check. Every 220 minutes in Float charge, battery efficiency test. Battery Faults can be monitored by relay and led blinking.

10.1 BATTERY CHARGE IN TEMPERATURE COMPENSATED ENVIRONMENT

No. 11 Remove the window label to find the connector: Auxiliary Output "AUX 1"

It is possible to connect the Temperature sensor probe and apply it on the battery. The function of the probe is for temperature battery compensation. With this it is possible to meet the requirements of the EN54- fire certification.

Size 1,2,3

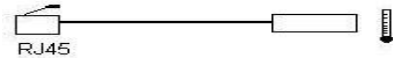

Size 4,5

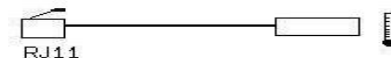

10.1.1 Battery Temperature Compensation Charge (not for LI-ion)

Connecting the cable RJTEMP (supplied separately) to Auxiliary Output AUX1, the CBI will adjust the battery charging voltage in relation to the Battery temperature :

Fast Charge: Open Lead, AGM, Gel	Float charge: Open Lead, AGM, Gel
+/- 5mV/°C x n. of Cells from -8°C to +60°C +140 ÷ -200 mV/Cell compared to the value at 20°C	+/- 3mV/°C x n. of Cells from -20°C to +60°C +120 ÷ -120 mV/Cell compared to the value at 20°C
Fast Charge: Ni-Cd	Float charge: Ni-Cd
+/- 2.5 mV/°C x n. of Cells from -20°C to +60°C +100 ÷ -100 mV/Cell compared to the value at 20°C	+/- 2.5 mV/°C x n. of Cells from -20°C to +60°C +100 ÷ -100 mV/Cell compared to the value at 20°C

The device stops charging the battery if the temperature is below -20°C or above +60°C. The sensor placed on cable RJTEMP must be applied on the battery.

10.2 CHARGING CURRENT LIMITER:

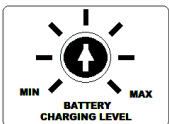

No.3 In order to protect the battery from excessive charging currents, the device allows to limit the maximum charge current by adjusting the trimmer from 20% (Size 1, 2, 5) or 10% (Size 3, 4) to 100% of the rated current. To determine the maximum battery charge current, see the battery manufacturer's Data Sheet or, if not available, consider that typically the maximum charge current is 10% of Ah's rated battery current, for both Lead

Acid Li-ion and NiCd batteries.

10.3 BATTERY MANAGEMENT CONFIGURATIONS

Completely automatic, all devices are suitable to charge most batteries types thank to User Selectable charging curves. They can charge open lead acid, sealed lead acid, Gel, Ni-Cd and Li-Ion. It is possible to change or add other charging curves connecting the device to a DPY351 or ADELViewSystem.

10.3.1 Battery Management Configurations (Sizes 1, 2, 3, 4)

No.18 Preliminary Operations: One device for all battery types.

Caution: Switch off the system before Setting the jumper. Only jumper in position 6 is Refreshed also with power ON.

10.3.2 Battery Management Configurations (Size 5: CBI60)

Note: it is also possible to configure the device via Webserver (section 13).

In normal operation the LED bargraph (No.19 in sect.7) gives an indication of the current (0 to 100% of I_n) as follows:

- In charge mode with mains: battery charge current with **solid** light
- In backup mode without mains: battery discharge current with **blinking** light
- In boost mode with mains: battery discharge current with **flickering** light

To display the current device configuration on the LED bargraph press the Config/Start button (No.9 in sect.7) briefly (< 1 sec). The display returns to normal operation after 10 seconds. Please refer to the pictures at the end of this section.

To change the device configuration complete the procedure below (note: if the procedure is not completed no settings are saved; the procedure is aborted is no command is given for 60s).

- With battery disconnected:
 - press the Config/Start button (No.9 in sect.7) for more than 2 seconds, until the first led starts blinking
 - press briefly the button to cycle through the battery types as shown by LEDs 1,2,3 (please refer to the pictures at the end of this section) then confirm with a long press until the 4th LED starts blinking
 - LED 4: Config Mode: ON/OFF
 - Long press to enable all other configurations via Web Server and ADELViewSystem (Led ON).
 - Short press to configure all parameters from Device only (Led OFF)
 - If Config Mode was selected, the procedure terminates here
 - LED 5: Option: not used: continue with a short-press
 - LED 6: Life Test; long press to enable the function (Led ON), short press to disable
 - LED 7: Fast Charge; long press to enable the function (Led ON), short press to disable
 - LED 8: UPS Disable; long press to disable the UPS function (Led ON), short press to keep it enabled
 - LED 9: Buffering time: press briefly the button to select the max backup duration, then confirm with a long press. The current selection is shown with other LEDs blinking together with LED 9 as follows:
 - Led 1: 30 sec; Led 2: 120 sec; Led 3: 300 sec; Led 4: 10 min; Led 5: 15 min; Led 6: 20 min; Led 7: 30 min; Led 8: 45 min; All leds: Infinite time
 - Note: the last selection (infinite time) is confirmed automatically also with a short press
 - More values can be selected by with DPY351 or ADELVIEWSystem
 - End Programming: the device show the selected configuration for 10 seconds then resumes normal operation,
- With battery connected:
 - press the Config/Start button (No.9 in sect.7) for more than 2 seconds, until the 5th led starts blinking
 - follow the procedure above from step “LED 5: Option” (Battery Type and Config Mode can be changed only when the battery is not connected).

Battery Type Selection (Only for CBI485A and CBI485A/S). "Size 2"						
	Jumper Position (Size 1)	Jumper Position (Size 2)	Jumper Position (Size 3)	Dip Switch Position (Size 4)	Float charge (Volt/Cell)	Fast charge (Volt/Cell)
Open Lead					2.23	2.40
AGM Low					2.25	2.40
AGM High					2.27	2.40
Gel Battery					2.30	2.40

Battery Type chemistry Selection							
	Jumper Position (Size 1)	Jumper Position (Size 2)	Jumper Position (Size 3)	Dip Switch Position (Size 4)	LED Config (Size 5)	Float charge (Volt/Cell)	Fast charge (Volt/Cell)
Open Lead						2.23	2.40
(AGM) Low						2.25	2.40
Gel Battery						2.30	2.40
Ni-Cd						1.4V/cell (12V:10 cells) (24V:20 cells) (48V:40 cells)	1.45V/cell (12V:10 cells) (24V:20 cells) (48V:40 cells)
Li-Ion (4) LiFePo4						3.45V/cell 12Vfield: 13.8V 24Vfield: 27.6V 48Vfield: 55.2V	3.65V/cell 12Vfield: 14.6V 24Vfield: 29.2V 48Vfield: 58.4V
Config Mode (5)						Configure with DPY351 or ADELViewSystem or Web Server for CBI60	

Functional Setting					Function	
Battery Life test ON						Jumper present or dip switch ON: Life test enabled (not for NiCd)
Fast Charge Enable (3)						Jumper present: Fast Charge enabled. Remote Fast Charge enabling possible by RTCONN cable
"Start from Battery" (No Input Mains)(1)						System switch ON from battery without mains. For connection to external Push button use RTCONN cable
UPS Disabling (2)						If jumper removed: UPS function disabled. Use RTCONN cable for connection to external Contact.

Note:

- Do not leave the jumper in position 5 (Size 1, 3) or position 6 (Size 2) or Battery Start (Size 4); otherwise, in Backup mode the battery is discharged completely close to zero. For Size 2 CBI2410A/S or CBI485A/S are required (/S means start with battery functions, otherwise only start with Input Mains)

- 2 For the CBI2420A, CBI1235A, CBI4810A, CBI size1 SDXX, CBI size2 SDXX, the function “fast charge” is replaced by “UPS disable”:
 - Contact closed: back-up (UPS) enabled. The System shuts down after xx min., depending on the Buffering time selected.
For devices CBI size1 SDXX, CBI size2 SDXX, depends on time minutes required in SD version. To maintain the contact always closed insert the jumper permanently.
 - Contact open: Inhibit backup function. No UPS enabled.
 - For CBI2420A, CBI1235A, CBI4810A: the function is not enabled if Time Buffering is in position Zero. In position Zero, the jumper Fast is enabled otherwise the function is “UPS disable”.
 - In the CBI size1 SDXX, CBI size2 SDXX,: the Jumper Fast, it is always enabled
- 3 Jumper present in Fast Charge means also that every 288h, the device goes in “Cycling Refresh Charging”. This mode continues for 85 minutes at the same voltage condition: e.g. 2.4V/Cell for Lead Acid Batteries.
- 4 The Li-Ion curve is available starting from release: **Size1**:12Vdc Output: S13 R6; 24Vdc Output: S13 R7 **Size2**: 24Vdc Output: S92 R3 **Size3**:12Vdc, 24Vdc, 48Vdc Output: S40 R13 **Size4**: S130 R5
- 5 With this selection it is possible to change the parameters of the selected chemistry.
 - a. First, select the battery chemistry
 - b. Select “Config Mode”.
 - c. Change the parameters with DPY351 or ADELVIEWSystem. After update, it is possible to disconnect the programmer and use the device as standalone device.
 - d. If “Config Mode” is disable, all parameters are reset to their default values for the selected chemistry
 - e. In “Config mode”: it is possible to change the Float voltage and the Bulk voltage. To change the Bulk Voltage you have to modify the Holding register 40073 Bulk and 40077 Absorption.
 - f. In “Config Mode”, the Jumper **Size3** or Switch **Size4** for Fast Charge loses his function. All functions are driven from the Holding Register settings.

10.4 DIAGNOSTIC AND CONTROLS

All CBI devices support the user during installation and operation. A Blink code of Diagnosis Led allows to discriminate among various possible faults.

Error conditions, “LED Battery Fault” ON and “LED Diagnosis” blinking with sequence; see Display Signal section.

- Check for accidental disconnection of the battery cables and immediately switch off the output power.
- Battery not connected: If the battery is not connected the device provides alarm within 10 sec.
- Test of quality wire connections: During Float charge the quality (resistance) on the battery connection is checked every 60 sec. This to detect if the cable connection has been properly made.
- Battery in Open Circuit or Sulphated: In Float charging mode, the All In One performs internal impedance test every 220 minutes.
- Reverse Polarity check: If the battery is connected with inverted polarity, the All In One is automatically protected.
- Test of battery voltage connections: Appropriate voltage check, to prevent connection of wrong battery types, above or below nominal voltage.
- End of Charge check : When the battery is fully charged, the device automatically switches in Float charging mode.
- Check for Battery Cells in short circuit: thanks to specific algorithms of evaluation, the Alle In One recognizes batteries with shorted cells. In Float charge every 220 minutes a short-circuit test is carried out.

10.5 PROTECTION FEATURES

- **On the primary side**: the device is equipped whit an internally fuse. If the internal fuse is blown, most likely there is a fault in the device. In that case, the device must be returned to factory for repair.
- **On the secondary side Battery and load**: The device is electrically protected against short circuits and overload.
- **Polarity Inversion**: the module is automatically protected against inversion of battery polarity.
- **Over current and output short circuit**: the unit limits the output current (see the technical data).
- **Deep discharge**: not possible. The unit disconnects the battery when a minimum voltage level is reached.

10.6 CHARGING CURVE

Automatic multi-stage operation and real time diagnostic allows fast recharge and recovery of deep discharged batteries, adding value and reliability to the system hosting the CBI device. The type of charging is Voltages stabilized and Current stabilized IUoU. Five charging phases are identified by a flashing code on a Diagnosis LED. To maintain the Output Load close to the nominal voltage (12, 24, 48), don’t insert jumper in position 6 to disable fast charge. Fast Charge means also that every 288h, the device goes in “Cycling Refresh Charging” for 85 minutes at 2.4V/Cell.

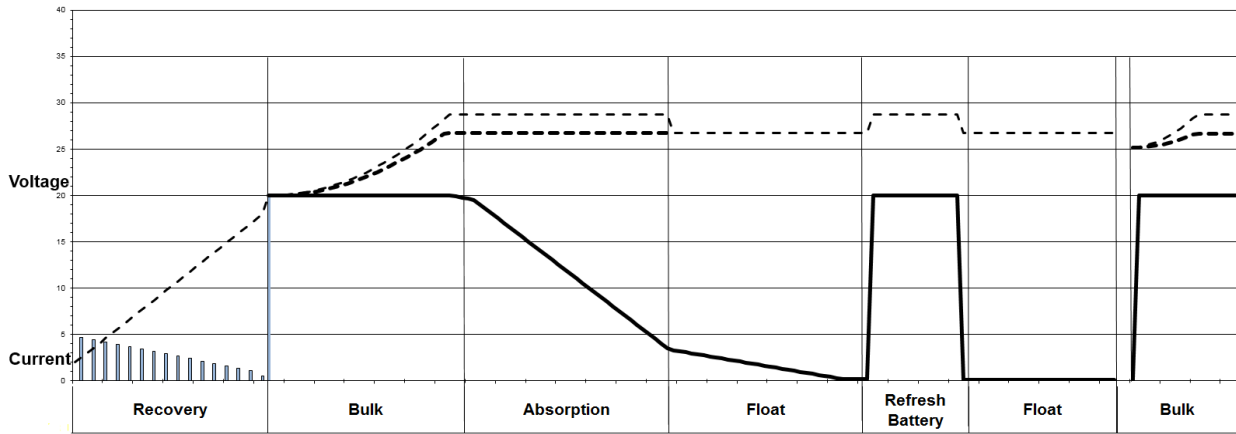

10.7 THERMAL BEHAVIOUR

Surrounding air temperature 50°C. For ambient temperature above 50°C, the output current must be reduced by 2.5% per °C. Max 70°C At the temperature of 70°C the output current will be 50% of In. The equipment does not switch off in case of ambient temperature above 70°C or thermal overload. The devices are protected for Over temperature conditions “worst case”; in this situation the device shuts down the output and automatically restarts when the inner temperature falls within limit.

11 MODBUS (SIZE 3 - 4)

Some devices are fitted with a Modbus “RTU” communication protocol port; Modbus requires that only one device be the Master, all other devices must be slave.

Hardware interface: RS485.

11.1 ELECTRICAL CHARACTERISTICS

The unit is a **SLAVE** in a MODBUS network, with the following specifications:

Transmission mode:	MODBUS RTU
Electrical Interface:	RS485 half-duplex serial line
Baud rate:	4800 / 9600 / 19200 / 38400 (default) bps
Data format:	8 data bits
Parity:	even (default) / odd / none
Stop bits:	1 (parity odd or even) / 1 or 2 selectable (parity none)
Slave address:	configurable in the range 1 (default) to 247
Connector type:	RJ45
Cable:	wire RJ-45 plug

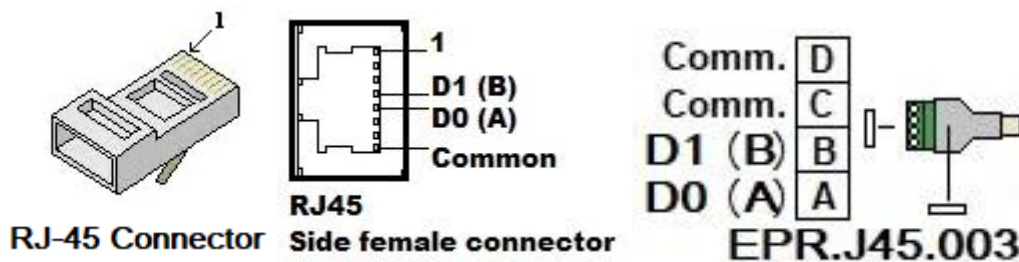

	Size3 - 4
Connector name	AUX2 - AUX3
Pinout (see fig. above)	A = pin 5, B = pin 4, Common = pin 3

11.2 HOW TO CONNECT THE DEVICE TO MODBUS

11.2.1 Daisy Chain general connection Diagram

To connect the device to Modbus, please use AUX2 and AUX3 Port.

- Port: AUX 2 No. 13 is Present only in Sizes 3 and Sizes 4, MODBUS connection via RJ45 connector.
- Port: AUX 3 No. 14 Present only in Size 4. The function is the same of Auxiliary Output “AUX 2”

11.2.2 Connection Diagram Size3 and 4

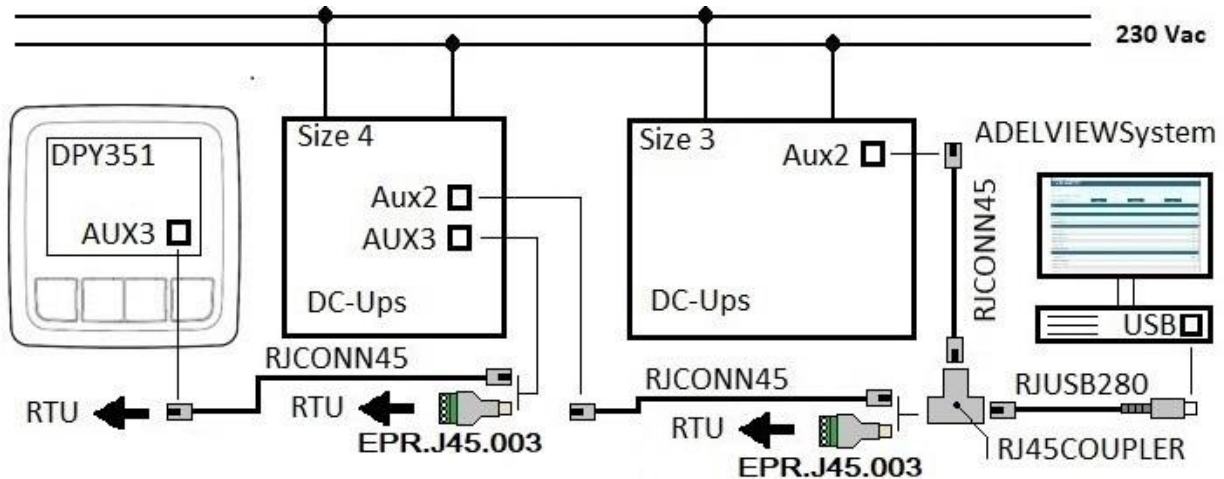

- RJCONN45: normal RJ45 cable also provided by ADELSystem. It is possible to connect in daisy chain up to 32 devices, max distance 1000m, from the Output AUX2 and Aux3.
- In the connection scheme shown above, each slave device must have a unique Modbus device address for proper communication. In order to avoid signal noise, the use of line termination resistors (120 Ohm) is recommended. The effect of signal noise becomes more relevant with long cable length and/or high baud rates. The serial Modbus connection uses an RS485 port for connection between the master port and the corresponding interfaces of the slave according to the EIA/TIA RS485 standard.
- RJUSB280: cable interface RS485 – USB, max length 2m, for connection to PC
- Note: If both, DPY351 and ADELViewSystem, are running in the same network at the same time, The DPY351 must be set in Modbus “Viewmode”.
- RJ45COUPLER: is a T connection RJ45 for daisy Chain with CBI Size3 and 4

11.2.3 Bus Termination (Size 3)

The fail safe and Line termination resistor for the RS-485 bus, are not provided inside the device and must be installed externally, if necessary, according to the following scheme.

Fail-safe:

- 560 Ohm (Pull Up) to 5 V: Not Present
 - 560 Ohm (Pull Down) to common: Not Present
- Load Terminations:
- 120 Ohm (LT) between lines A – B: Not Present

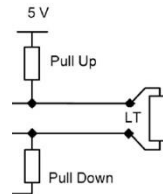

11.2.4 Bus Termination (Size 4)

No.16: The Size 4 device includes a full “fail safe” polarization and the bus termination. In the CBI2801224A the fail safe function and line terminators can be individually enabled or disabled by means of the dip-switches located on its front panel, as shown in the following figure:

Fail-safe:

- Fail Safe A, 560 Ohm (Pull Up) to 5 V
- Fail Safe B, 560 Ohm (Pull Down) to 0 V
- Terminations: 120 Ohm (between Modbus lines)
- Terminations: 120 Ohm (between Can lines)

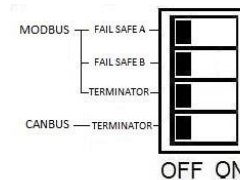

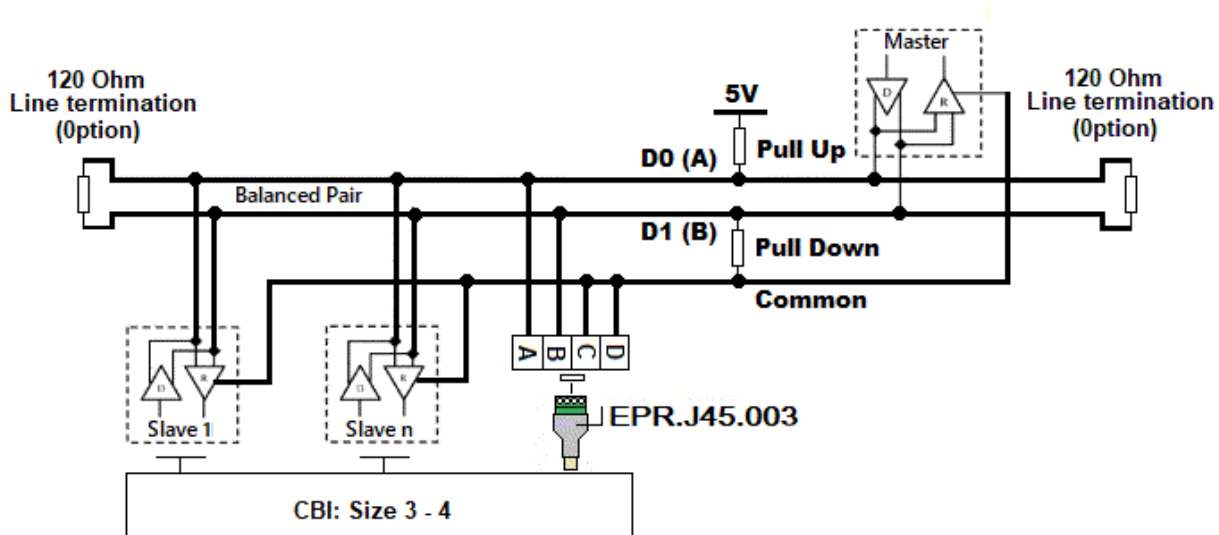

11.3 HOW TO CONFIGURE MODBUS

AUX2 and AUX3 ports, are provided for the connection to an external device like: RTU, PC , DPY351.

- For the connection to RTU, PLC or similar devices, refer to the instruction manuals “Modbus specifications” available in the Web Site: www.adelsystem.com
- For configuration and monitoring of the parameters inside the devices, download and install “ADELViewSystem” from the Web Site: www.adelsystem.com.
- Download the Modbus table from Web Site: www.adelsystem.com, section Additional Data, with details About all data and parameters exchanged between a CBI and a Master Device.
- For the Monitoring and Configurations of one or more ADELSystem devices from enduser friendly , please use the Plug and Play unit DPY351.
- For all details of Modbus configuration refer to the instruction manuals “Modbus specifications” available from the Web Site: www.adelsystem.com, section Additional Data.

12 ADELBUS CONNECTIONS

ADELBus is the ADELSystem network to interconnect devices via Modbus and CANBUS protocols.

ADELBus is used as power management system for all connected equipment, such as the DC-Ups, Battery Charger, Power Supply. Every compatible device with ADELBus is equipped with one or two data ports. The devices are simply chained together, forming a local data network. Monitoring panels such as the DPY351 can be used for monitoring and controlling all connected ADELBus equipment.

12.1 EVENT BASED COMMANDS

With the ADELBus, a device can be programmed to initiate an action on another connected device. This is done by means of event-based commands.

12.2 HOW TO SET UP AN ADELBUS NETWORK

Connections between the devices are made by standard straight ADELBus cables. ADELSystem can supply these cables. These (CAT5) cables are also commonly available at computer supply stores. Twisted pair cable with shield is recommended for CAN connection in noisy environment.

Up to 32 ADELBus devices can be connected together.

The power for the network can be provided directly to the connected devices through the ADELBus cable. Otherwise, if that is not sufficient, it is necessary to connect the device by the + and – terminals of connector 1 .

12.3 HOW TO SET ADELBUS NETWORK WITH MORE THAN ONE DPY351 (MODBUS VIEW MODE)

In a Modbus network there can only be one master. Normally the DPY351 is the master, it polls the network and it receives information from other ADELSystem devices, which are the slaves. If it is necessary to connect N DPY351 in the same ADELBus network, then $N-1$ displays shall be configured in View Mode. In this case only one DPY351 is a master and it polls the devices, the other DPY351s receive the data from the Bus and they take the information into consideration only if these parameters are originated from a device in their list, otherwise they ignore the information.

View Mode is useful also when the master of the network is an external device such as a PC, but there is the need to monitor the status of the network from other places.

To configure the DPY351 in View Mode it is necessary to go in:

Menu>Menu Config>Other Settings>Modbus View Mode.

13 ETHERNET CONFIGURATION

Configuration of the Ethernet interface by HTTP server via the Web browser:

13.1 CONNECT HTTP SERVER FOR THE FIRST TIME

Connect the device to the network with a standard CAT5e or better LAN cable plugged in to the Aux4 connector (RJ45) on the bottom of the unit, as shown in section 7 drawing Size5. The CBI60 is factory-configured to operate with a fixed IP address (192.168.1.100) on the standard HTTP port (number 80).

A different static IP address can be assigned to the CBI60 or a dynamic IP address can be assigned using the DHCP protocol. The network configuration can be carried out using the internal webserver. Type the IP address of the CBI60 into any browser's address bar (as an example "192.168.1.100") then the login page appears requesting the username and the password .

To access the internal webserver, at the login page, the following credentials must be used:

Username: admin

Password: admin

Note: after 20 minutes of inactivity the login credentials must be entered again.

13.1.1 Customizing the ethernet interface and services

In the main page, the following groups of parameters and other information are displayed:

- Account
- TCP/IP Configuration
- SNMP
- Device status
- Device settings
- System information

13.1.2 Account:

The Account group (Fig. 6) allows the customization of the data for the HTTP server login page. Any changes must be confirmed with the "Apply" button at the bottom of the page.

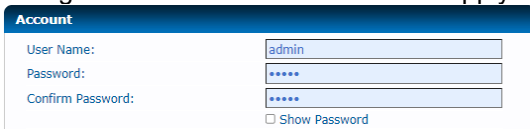

Account	
User Name:	admin
Password:	*****
Confirm Password:	*****
<input type="checkbox"/> Show Password	

Fig. 6 – Account settings

13.1.3 TCP/IP Configuration

Fig. 7 shows the TCP/IP Configuration group with parameter default values. They allow unique identification of the unit in the network.

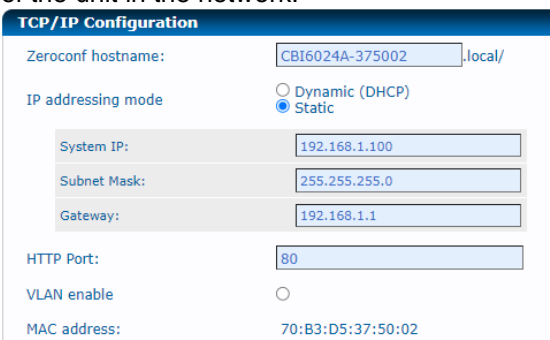

TCP/IP Configuration	
Zeroconf hostname:	CBI6024A-375002.local/
IP addressing mode	<input type="radio"/> Dynamic (DHCP) <input checked="" type="radio"/> Static
System IP:	192.168.1.100
Subnet Mask:	255.255.255.0
Gateway:	192.168.1.1
HTTP Port:	80
VLAN enable	<input type="radio"/>
MAC address:	70:B3:D5:37:50:02

Fig. 7 – IP settings

If "Dynamic (DHCP)" is selected, the IP address is automatically assigned by a DHCP server, that must be active on the network; in this case the System IP, Subnet Mask and Gateway textboxes show the assigned values and are not editable.

HTTP Port allows redirecting the HTTP traffic to a port different than the standard HTTP port 80. In that case, access to the HTTP server from a browser must be made using the syntax <http://ipaddress:portnumber>.

As an example, if the IP address is 192.168.1.100 and the selected HTTP port is 5678 then the following IP string should be entered in the browser <http://192.168.1.100:5678>.

The CBI60 supports access using the Virtual LAN protocol. In the case "VLAN ID" checkbox is not selected the CBI60 will not operate in the VLAN. If "VLAN ID" checkbox is selected then a "VLAN ID" textbox will appear and should be populated with an ID in the range 1 thru 4094, matching the one of the VLAN the unit is operating in.

Any changes must be confirmed with the "Apply" button at the bottom of the page.

13.1.4 SNMP

The CBI60 can act as SNMP manager. An ADELsystem MIB table file is provided which consists of a list of parameters that can be remotely read, or read-written through the SNMP protocol. Each parameter (OID) is mapped one-to-one to a Modbus RTU holding register. Refer to the document “Adelsystem parameter table” for the description of each parameter and the corresponding OID for the SNMP.

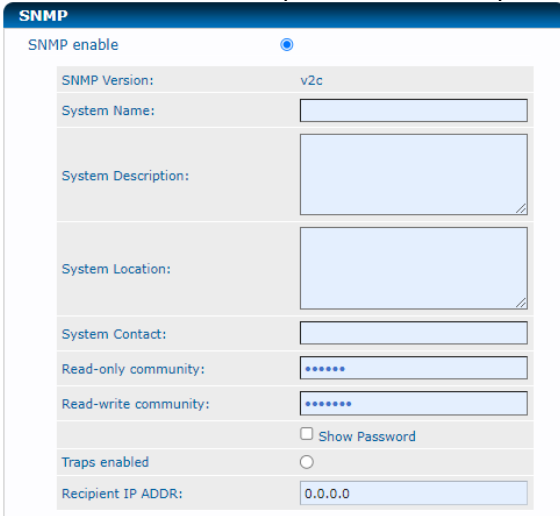

Fig. 8 – SNMP settings

All the fields in the SNMP group of settings allow a maximum of 31 characters, except “System Description” and “System Location”, which allow 255 characters maximum. The “Read-only community” and “Read-write community” values must match those of the SNMP environment the unit operates in, otherwise the device management using SNMP will not be possible.

Any changes must be confirmed with the "Apply" button at the bottom of the page.

13.1.5 Device status

This group shows the main operating parameters of the device.

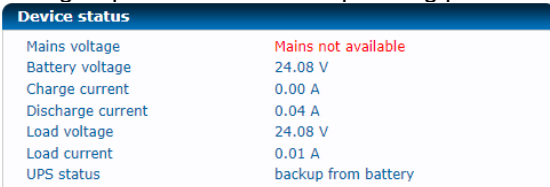

Parameter	Value
Mains voltage	Mains not available
Battery voltage	24.08 V
Charge current	0.00 A
Discharge current	0.04 A
Load voltage	24.08 V
Load current	0.01 A
UPS status	backup from battery

13.1.6 Device settings

This group replicates the settings also accessible on the CBI60 front panel by pressing the CONFIG button (refer to section 10.3.2 of this manual). Any changes must be confirmed with the "Apply" button at the bottom of the page.

“Battery type” selects the battery chemistry from a drop-down list.

If “Configuration mode” is selected Led 4 ON, the following parameters (Lifetest, Fast charge, UPS enable and Buffering time) cannot be changed as they are controlled remotely via Modbus or SNMP.

If “Configuration mode” is not selected Led 4 OFF, the following settings are available: “Lifetest”, “Fast charge”, “UPS disable” and “Buffering time”.

The following information “Charging current limiter” is read-only and corresponds to the position of the charging current limiting trimmer on the front panel (see section: 10.2).

Finally the “Reset” button allows to reboot the device remotely, only if no battery connected. Current settings will be maintained. Any changes not saved with the “Apply” button will be lost.

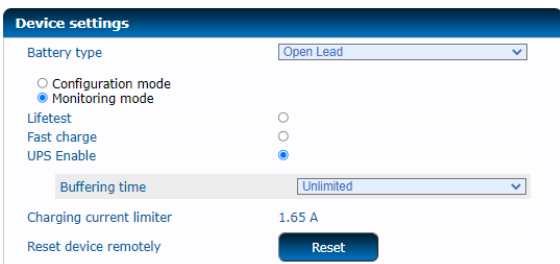

Fig. 9 – Device settings

13.1.7 System information

This group shows detailed information on device and the installed software components, to be communicated to the service technician if requested. Fig. 10 shows example information: the actual values may be different.

The “Update” button allows to update the application software. Only valid software images for the CBI60 will be accepted. Update is only possible when the device is powered from mains.



Fig. 10 – System information

13.1.8 Saving the customized parameters

To save the changes into the CBI60 non volatile memory press the “Apply” button at the bottom of the page.

13.2 HOW TO PUT INTO DEFAULT VALUES THE DEVICE (CUSTOMER SERVICE)

13.2.1 Resetting the customized parameters to their default values

In case the login user name or password was forgotten, or the TCP/IP configuration was set incorrectly and the device is no longer reachable, please follow this procedure to restore the default settings:

- Turn OFF the device
 - Press the CONFIG button on the front panel and keep it pressed
 - Turn ON the device and continue to keep the button pressed (all the 9 configuration LEDs will stay ON during this time)
 - After 5 seconds the 4 top configuration LEDs (n. 6 to 9) will blink alternatively in pairs and the LED 1 will blink slowly showing “Option 1”
 - Release the button
 - Now click briefly on the button to select one of 4 options, as shown by the config LEDs 1 to 4. The options are:
 - 1: forces Dynamic (DHCP) IP Addressing Mode (DHCP) until reboot; the TCP/IP configuration must be changed on the HTTP server in order to make this setting permanent.
 - 2: system recovery application, only to be used if instructed by customer service
 - 3: restore login credentials, TCP/IP and SNMP settings to factory default
 - 4: restore the complete device to factory settings – WARNING: all user’s settings and logs will be lost, including the battery type selection.
- Confirm the choice by keeping the CONFIG button pressed for 5 seconds until LEDs 6 to 9 stop blinking.

14 PC SHUTDOWN

For the Shutdown PC please refer to the special White Paper in the Web Site

15 STANDARD AND CERTIFICATIONS

15.1.1 Electrical Safety for Mounting:

Device assembling: UL508, IEC/EN 60950 (VDE 0805) and EN 50178 (VDE 0160). Installation: IEC/EN 60950. Input / Output separation: SELV EN 60950-1 and PELV EN 60204-1. Double or reinforced insulation. Safety of Electrical Equipment Machines: EN 60204-1.

 according to EMC 2014/30/UE and Low voltage directive 2014/35/UE

15.1.2 Safety Standards:

EN IEC 62368-1: 2014/AC:2015

15.1.3 EMC Standards Immunity:

EN 61000-4-2, EN 61000-4-3, EN 61000-6-2, EN 61000-4-4, EN 61000-4-5.

15.1.4 EMC Standards Emission:

EN 61000-6-4, EN 61000-6-3, EN 61000-3-2 (see data sheet for each device)

15.1.5 Conformity to:

EN60950/UL60950-1 and CSA C22.2 No. 60950-1-07 (Information Technology Equipment) – Safety – Part1: General Requirement. 

Device is intended to be installed in a cabinet protected from external shocks or damages.

Electrical safety EN54-4 Fire Detection and fire alarm systems

DIN41772: Charging curve; DIN41773: Characteristic Curve for charging Lead Acid and Nickel-Cadmium batteries.

15.1.6 Approvals:

Devices, CBI243A, CBI245A, CBI123A, CBI126A, CBI1210A, CBI2410A and \S, CBI485A and \S, CBI1235A, CBI2420A, CBI4810A
EN60950 / UL60950-1 and CSA C22.2 No. 60950-1-07 (Information Technology Equipment) – Safety – Part1: General Requirement. 

16 DIN RAIL MOUNTING:



All modules must have a minimum vertical and horizontal distance of 10 cm to this power supply in order to guarantee sufficient auto convection. Depending on the ambient temperature and load of the device, the temperature of the housing can become very high.

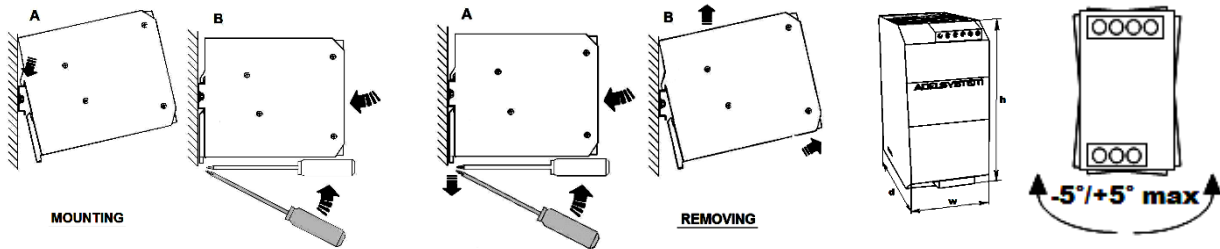

17 TECHNICAL DATA

For all technical data, please download the data sheet on the relevant Website for the specific Product

18 BATTERY BANK

18.1 BATTERY BANK 12V

- BATT 123: Battery Bank 1 Battery+Enclosure
- BATT 123DIN: Battery Bank 1 Battery+Enclosure DIN
- BATT 127: Battery Bank 1 Battery+Enclosure
- BATT 127DIN: Battery Bank 1 Battery+Enclosure DIN
- BATT 1212: Battery Bank 1 Battery+Enclosure

18.2 BATTERY BANK 24V

- BAT1.2VRLA: Battery Bank 2 Batteries+Enclosure DIN
- BAT3.4VRLA: Battery Bank 2 Batteries+Enclosure DIN
- BAT7.2VRLA: Battery Bank 2 Batteries+Enclosure DIN
- BAT12VRLA: Battery Bank 2 Batteries+Enclosure
- BTH1.2VRLA: Battery Bank Enclosure No Battery DIN
- BTH3.4VRLA: Battery Bank Enclosure No Battery DIN
- BTH7.2VRLA: Battery Bank Enclosure No Battery DIN
- BTH12VRLA: Battery Bank Enclosure No Battery

19 ACCESSORIES

19.1 DIGITAL CABLE

- RJTB500
- RJ45COUPLER
- DPYCONN500
- RJCONN45
- RJUSB500
- RJUSB280
- RJUSBSD

19.2 TEMPERATURE SENSORS

- RJTEMP451
- RJTEMP453
- RJTEMP111
- RJTEMP113

19.3 CABLE CONNECTORS

- RTCONN

19.4 REDUNDANCY

- MR220 DECOUPLER

20 MONITOR & CONTROL

20.1.1 DPY351 CONTROL PANEL

20.1.2 DPY353 DISPLAY PANEL

20.1.3 DPY354 "ADELVIEW SYSTEM" PC SOFTWARE